

SIEMENS

SIMATIC

PDM V5.2 The Process Device Manager

Manual

Preface, Contents	
Product Introduction	1
Starting SIMATIC PDM	2
Configuring Networks and Devices	3
SIMATIC PDM Integrated	4
Working with SIMATIC PDM	5
Loading of Data Between Various Devices	6
Importing/Exporting Configuration and Parameter Data	7
Distributed Editing of Projects	8
Communication	9
SIMATIC PDM LifeList	10
Device Install	11
Index	

Preface

Purpose

This manual provides a complete overview of programming with **SIMATIC PDM**. It is designed to support you when installing and commissioning the software. It explains the procedure for configuring networks and process devices as well as the commissioning and run-time functions.

The manual is intended for persons who are involved in the configuration, commissioning and operation of the plant in the field of field control technology.

Basic Knowledge Required

In order to understand this manual, general knowledge of field control technology is required.

In addition, you must be familiar with using PCs with Windows operating systems.

If used with STEP 7 and PCS 7, a corresponding knowledge in the field of automation technology and SIMATIC S7 are required.

Scope of the Manual

This manual is valid for release 5.2 of the SIMATIC PDM programming software package.

Online Help

The manual is complemented by an online help that is integrated in the software. This online help is intended to provide you with detailed support when using the software.

The help system is integrated in the software via a number of interfaces:

- There are several menu commands that you can select in the **Help** menu: The **Contents** command opens the index for the Help on SIMATIC PDM.
- The context-sensitive help offers information on the current context, for example, an open dialog box or an active window. You can open the context-sensitive help by clicking the "Help" button or by pressing F1.
- The status bar offers another form of context-sensitive help. It displays a short explanation for each menu command when the mouse pointer is positioned on the menu command.
- A brief explanation is also displayed for each icon in the toolbar when the mouse pointer is positioned on the icon for a short time.

If you prefer to read the information from the online help in printed format, you can print out individual help topics, books, or the entire online help.

This manual is an extract from the HTML-based Help on SIMATIC PDM. For detailed procedures please refer to the SIMATIC PDM help. As the manual and the online help share an almost identical structure, it is easy to switch between the manual and the online help.

Getting Started

The Getting Started "First Steps with SIMATIC PDM" contains the project "PDM_1", which makes it possible for you to create your own fully-functional project.

You can find the Getting Started "First Steps with SIMATIC PDM" on the CD "SIMATIC PDM V 5.2" in the folder "Docu" as the file "PDM Getting Started.pdf".

Further Support

If you have any technical questions, please get in touch with your Siemens representative or agent responsible.

<http://www.siemens.com/automation/partner>

Training Centers

Siemens offers a number of training courses to familiarize you with SIMATIC PDM and the SIMATIC S7 automation system. Please contact your regional training center or our central training center in D 90327 Nuremberg, Germany for details:

Telephone: +49 (911) 895-3200.

Internet: <http://www.sitrain.com>

Contents

1	Product Introduction	1-1
1.1	Field of Application.....	1-1
1.2	Introduction.....	1-1
1.3	What is New in SIMATIC PDM V5.2?	1-3
1.4	Authorization	1-5
1.5	Installing SIMATIC PDM	1-6
1.6	Removing SIMATIC PDM	1-6
2	Starting SIMATIC PDM	2-1
2.1	Starting SIMATIC PDM	2-1
2.2	Starting SIMATIC PDM in the Process Device Network View	2-1
2.3	Starting SIMATIC PDM in the Process Device Plant View	2-2
2.4	Starting SIMATIC PDM in HW-Config.....	2-2
2.5	Starting SIMATIC PDM in LifeList.....	2-3
3	Configuring Networks and Devices	3-1
3.1	Configuring Networks and Devices.....	3-1
3.2	SIMATIC Manager	3-5
3.3	SIMATIC Manager Views.....	3-6
3.4	Icons for Devices.....	3-8
3.5	SIMATIC PDM (not integrated in STEP 7/PCS 7)	3-9
3.6	Creating a Project in the Process Device Network View	3-9
3.7	Coupling a Device in the Process Device Network View.....	3-10
3.8	Creating a Project in the Process Device Plant View	3-13
3.9	Coupling a Device in the Process Device Plant View.....	3-13
3.10	Inserting Several Devices at the Same Time.....	3-13
3.11	Exchanging Devices.....	3-14
3.12	Deleting Devices	3-14
3.13	Information on Configuring and Parameterization	3-15
3.14	PROFIBUS	3-16
3.14.1	Coupling a PROFIBUS Device in SIMATIC PDM.....	3-16
3.14.2	Block Structure of the PROFIBUS Profile Devices	3-17
3.14.3	Distributed Periphery — Remote I/O Systems	3-18
3.15	HART.....	3-20
3.15.1	Coupling a HART Device to a HART Modem in SIMATIC PDM.....	3-20
3.15.2	Coupling a HART Multiplexer Network	3-21
3.15.3	Coupling HART Devices via HCF-DDs	3-26
3.16	SIPART	3-27
3.16.1	Coupling a SIPART DR Device to an RS 232C/RS 485 in SIMATIC PDM	3-27
3.16.2	Coupling a SIPART DR Controller	3-28
3.17	SIREC	3-30
3.17.1	Coupling a SIREC Network.....	3-30
3.17.2	Coupling a SIREC Process Recorder	3-31
3.18	MODBUS.....	3-32
3.18.1	Coupling a MODBUS Network.....	3-32

4	SIMATIC PDM Integrated	4-1
4.1	Creating a STEP 7 Project and Starting HW Config.....	4-1
4.2	Opening an Existing STEP 7 Project and Starting HW-Config.....	4-2
4.3	Coupling a Device in HW-Config.....	4-2
5	Working with SIMATIC PDM	5-1
5.1	How SIMATIC PDM Works	5-1
5.2	First Steps with SIMATIC PDM.....	5-3
5.3	Maintenance Engineer / Specialist.....	5-5
5.4	Main Window.....	5-6
5.5	Parameter Group Overview	5-6
5.6	Parameter Table.....	5-7
5.7	Log	5-9
6	Loading of Data Between Various Devices.....	6-1
6.1	Processing Results	6-2
7	Importing/Exporting Configuration and Parameter Data.....	7-1
7.1	"Import - In Process" Dialog Box.....	7-4
7.2	"Export - In Process" Dialog Box.....	7-5
8	Distributed Editing of Projects.....	8-1
9	Communication.....	9-1
9.1	Secure Communication.....	9-1
9.2	Communication Problems	9-2
9.3	Communication via SIMATIC S7 Stations (Routing).....	9-4
9.3.1	Routing.....	9-4
9.3.2	Creating a Routing Configuration.....	9-5
10	SIMATIC PDM LifeList	10-1
10.1	Introduction.....	10-1
10.2	Starting SIMATIC PDM	10-1
10.3	User Interface.....	10-2
10.4	"SIMATIC PDM LifeList" Dialog Box	10-3
10.5	"Options" Dialog Box.....	10-4
11	Device Install.....	11-1
11.1	Integrating Devices in SIMATIC PDM with "Device Install"	11-1
11.2	Integrating Devices in SIMATIC PDM with HW Config.....	11-2

Index

1 Product Introduction

1.1 Field of Application

This Help is for the SIMATIC PDM basic functions including an introduction to the configuration of networks and devices.

SIMATIC PDM works within a SIMATIC STEP 7 / PCS 7 environment or at least with function modules from it. This Help does not cover these areas!

SIMATIC PDM generates device-specific Help (e.g. on the meaning of variables etc.) from the respective Device Descriptions (DDs). This Help does not cover specific devices!

SIMATIC PDM undertakes no guarantee of and liability for the correctness and completeness of the aforementioned Help that is not part of SIMATIC PDM!

1.2 Introduction

SIMATIC PDM is a software package for configuring, parameterizing, commissioning and maintaining devices (e.g. transducers) and for configuring networks.

SIMATIC PDM contains a simple process monitoring of the process values, alarms and status signals of the device.

SIMATIC PDM is an open tool for device integration. There are already 1,000 devices from more than 100 device manufacturers integrated in it. The basis for device integration is the EDDL (**E**lectronic **D**evice **D**escription **L**anguage). The EDD (**E**lectronic **D**evice **D**escription) is created by the device manufacturer or another service provider. It is supplied along with the device on a data carrier, made available on the Internet or integrated into device catalogs for EDD applications.

Options

The standard version of **SIMATIC PDM** can use 4 TAGs (a "TAG" is a device) simultaneously in a project. If you want to use more than 4 TAGs per project, you can also order SIMATIC PDM with 128 TAGs up to an unlimited number of TAGs.

With the "Integration in STEP 7/PCS 7" option, SIMATIC PDM is based on the SIMATIC STEP 7 or SIMATIC PCS 7 software package and is permanently integrated as an optional package in the existing installation. This option also allows the configuration of PROFIBUS-DP/PA networks and devices with the aid of STEP 7 HW-Config.

The combination of SIMATIC PDM and the Integration in STEP 7/PCS 7 option is referred to below as **SIMATIC PDM Integrated**.

Sample projects

SIMATIC PDM come with the following sample projects:

- DPPA: this project contains a PROFIBUS device (Sitrans P) and an ET200M with HART devices on an analog input module.
- HART: this sample project contains a HART device (Sitrans TK-H).
- Multiplexer: this sample project contains a multiplexer and a HART device (Sitrans P ES).

These sample projects can only be used with STEP 7 or PCS 7 and the "Integrated" option.

1.3 What is New in SIMATIC PDM V5.2?

SIMATIC PDM LifeList

In SIMATIC PDM V5.2 SP1, the SIMATIC PDM LifeList program was revised. This program is intended to provide you with an overview of all accessible field devices. With it, you can find PROFIBUS DP/PA and determine the HART devices connected a HART modem (in single or multi-drop operation).

- You can change the addresses and TAGs of devices directly in SIMATIC PDM LifeList.
- By double-clicking on a selected device, you can start SIMATIC PDM directly from LifeList; it is not necessary to create project.
- You can have your project compared directly through LifeList or add the devices found to projects by importing and exporting.

For PROFIBUS devices you require an authorization for at least 128 TAGs.

If you use SIMATIC PDM with STEP 7, you must use STEP 7 V5.1 SP4 or higher to be able to start SIMATIC PDM LifeList.

ET200iS Support

With SIMATIC PDM V5.2 DP, you can now configure ET200iS stations and place them in operation.

To operate an ET200iS in SIMATIC S7 / PCS7, the following versions are required:

- PCS7 V5.2
- STEP7 V5.1 SP3 or higher

SIMATIC PDM in Windows 2000/Me/XP

- SIMATIC PDM V5.2 has also been approved and released for use in Windows 2000 and Windows Me.
- SIMATIC PDM V5.2 Service Pack 1 has also been approved and released for use in Windows XP.

Comparative Import

When importing project data (PDM files) you can select between the following import options:

- Comparative import (corresponding objects are overwritten) or
- Additive import (all imported objects are created again)

Integration of Siemens Process Recorders

The integration of Siemens process recorders means that an additional family of devices can be configured with SIMATIC PDM.

The following Siemens process recorders are integrated in SIMATIC PDM:

SIREC L / LA	Continuous-line recorder with/without alphanumerics capability	(FW 1.0 ... 1.5)
SIREC P / PA	Dotted-line recorder with/without alphanumerics capability	(FW 1.0 ... 1.5)
SIREC PU	Universal dotted-line recorder with/without mathematics capability	(FW 1.x ... 2.1)
SIREC VARIOGRAPH	Hybrid recorder	(FW 8.0 ... 8.3)

Integration of Further Device Profiles

- DI
- DO
- Coriolis
- Hydraulics
- Semiconductor devices

Update and Supplement of Supported Devices

The device descriptions of the supported devices were updated to the current version. The current catalog (December 2002) of the HART devices of the HART Communication Foundation (HCF) is integrated in this version.

Improved Product Structure

- The standard version of SIMATIC PDM contains the "Communication via PROFIBUS" option.
- The maximum number of TAGs (devices) that can be simultaneously used in the standard version of has been reduced to 4.
- The number of TAG options that can be ordered has been reduced. In addition, the "unlimited" option has been added.
- If you do **not** want to make use of the integration features in STEP 7 or PCS 7, you can then install both SIMATIC PDM and STEP 7 in parallel on one computer without having to also obtain the "Integration in STEP 7/PCS 7" option.

Exporting Configuration and Parameter Data

As of Service Pack 1, the configuration and parameter data of projects with PDM objects can be exported as PDM data and then imported to another location (such as to another project or another PC). When doing this, you have the option of starting SIMATIC PDM by double-clicking its icon in the Explorer.

SIMATIC PDM Application

As of Service Pack 1, you can insert new objects while in SIMATIC PDM and configure them there, as well as delete objects. The changes that you make in a project are applied only after you have selected the menu command **File > Save**.

Device icons

As of Service Pack 1, the device icons are also displayed in the network view of the SIMATIC Manager, SIMATIC PDM and in LifeList. The icons show the status of the device during the last communication with it.

Configuring Modbus Networks

As of Service Pack 1, you can also configure Modbus networks.

Activating/Deactivating Devices

As of Service Pack 1, the "General" tab ("Properties" dialog box) for a device contains the check box "Object activated". If you clear this check box, devices can be identified and excluded from loading operations.

1.4 Authorization

- A product-specific authorization (right to use) is necessary for using SIMATIC PDM. The protected program can only be used if the authorization required for the program is recognized on the hard disk of the PC/programming device concerned.
- Authorization for SIMATIC PDM is not identical with that for SIMATIC STEP 7/PCS 7 or other associated option packages.
- Please refer to the Authorization Instructions supplied for more information on the subject of authorization.

1.5 Installing SIMATIC PDM

SIMATIC PDM contains a Setup program that carries out the installation automatically. Input prompts on the screen guide you step-by-step through the entire installation process. The standard procedure under Windows 98/NT or Windows 2000/XP for installing software is called up.

The essential phases of the installation are:

- Copying the data to the path selected by you,
- The authorization (if desired, it can also be installed later).

Installation Requirements

- Microsoft Windows operating system; you will find detailed information in the Readme.wri file.
- Basic hardware
PC or programming device with
 - Pentium PC; you will find detailed information in the Readme.wri file.
 - RAM: you will find detailed information in the Readme.wri file.
 - Color monitor, keyboard and mouse that are supported by Microsoft Windows.

All the SIMATIC PDM files on the program CD are installed on a hard disk with the SETUP program. The files are stored in compressed form on the program CD and are decompressed during the transfer.

SIMATIC PDM cannot be started from the CD! After it has been installed successfully it can be started by clicking on the **SIMATIC Manager** icon.

1.6 Removing SIMATIC PDM

Use the usual Windows procedure for removing programs:

1. Start the dialog box for installing/removing software under Windows by double-clicking on the "Add/Remove" icon in the "Control Panel".
2. Select the "SIMATIC PDM" entry in the displayed list of installed software. Then click on the command button to "Remove" the software.
3. If "Remove released file" messages are displayed, click on the "No" command button, if you are not sure.

2 Starting SIMATIC PDM

2.1 Starting SIMATIC PDM

The following illustration shows the various way in which the "SIMATIC PDM" application can be started.

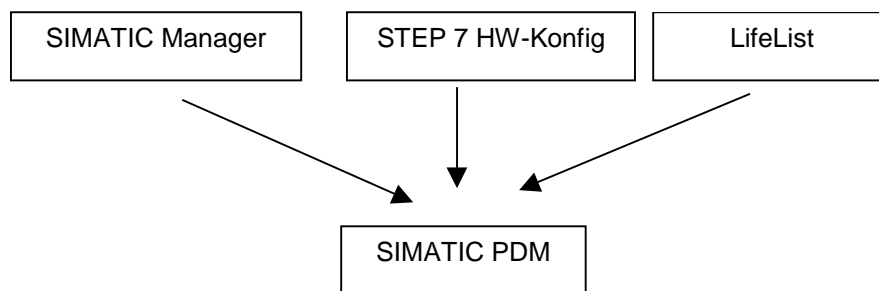

2.2 Starting SIMATIC PDM in the Process Device Network View

Start SIMATIC PDM by selecting the desired object or network and opening it with a right mouse click with the context-sensitive command **Open Object**. In many cases you can also start PDM by double-clicking on the device icon. If you did not specify the device type when you inserted the object, the "SIMATIC PDM Device Selection" dialog box is displayed when program is started for the first time. Here you will find the devices and profiles that are supported by SIMATIC PDM depending on the network. Select a device or a device profile. SIMATIC PDM will start once you have made the selection.

Notes:

- For further information on particular points pertaining to the distributed periphery please refer to the section on Remote I/O Systems.
 - The actual communication path is set in the configuration, not by the network from which the program was started.
-

2.3 Starting SIMATIC PDM in the Process Device Plant View

Start SIMATIC PDM by selecting the object and opening it with a right mouse click with the context-sensitive command **Open Object**. In many cases you can also start PDM by double-clicking on the device icon. If the program is being started for the first time, the "SIMATIC PDM Device Selection" dialog box is displayed.

This contains the devices and profiles for the MSR point which are supported by SIMATIC PDM. Select a device or a device profile. SIMATIC PDM will start once you have made the selection.

You will find at least one type name for the head station depending on the manufacturer. Assign the one suggested or select a different one. SIMATIC PDM will start once you have made the selection.

You can now parameterize the selected device completely off-line, i.e. create a parameter record in the off-line data storage. You cannot communicate with the device, however, as a network has not yet been assigned.

For further information about assigning a network please refer to the section on SIMATIC Manager Views.

For further information on particular points pertaining to the distributed periphery, please refer to the section on Remote I/O Systems.

2.4 Starting SIMATIC PDM in HW-Config

Start SIMATIC PDM double-clicking on the device icon or the device input in the detail view. When started for the first time, the program displays the "Insert SIMATIC PDM object" dialog box with a preset name. Enter a device-specific name, e.g. the system identifier. The name is displayed afterwards on the icon in the plant view and in the icon in HW-Config. Once you click on OK the **SIMATIC PDM device selection** dialog box is displayed. Here you will find the devices and profiles that are supported by SIMATIC PDM depending on the selection in HW-Config. Select a device or a device profile. SIMATIC PDM will start once you have made the selection.

Specify the network topology in the process device network view and insert all devices configured in HW-Config. When the devices are inserted the "Insert SIMATIC PDM Object" dialog box is opened. Click on the "Select" command button and select the project from the dialog box then displayed. All the devices configured in HW-Config are displayed and you can select the required device. Right-click on the selected project and select the entry **Details**. The right-hand section of the window now displays detailed information on the devices. The network column shows whether there is a network connection or not. This creates a link to the devices in the plant view. When you carry out this procedure, SIMATIC PDM can be started directly from HW-Config, from the plant view and from the network view by double-clicking the device icon.

Notes

- For special features of the distributed periphery please refer to the section Remote I/O SystemsRemote_I/O_Systeme.
 - If you use HW-Config for configuration, you should not change the device definitions later. Although this is possible in the process device network view (by replacing a device) and also affects HW-Config, the device-specific icon in HW-Config does not change and an incorrect PROFIBUS configuration may result. You will have to create a new device for another variant in HW-Config if necessary and may have to delete the old device.
 - Networks and devices that are configured in the process device network view are not transferred to HW-Config.
-

2.5 Starting SIMATIC PDM in LifeList

To start SIMATIC PDM, select its object, and then right-click to obtain the context menu. In this menu, select the command **Open object**.

In the header, LifeList shows the relationship to the project and the network used for communication. If you open SIMATIC PDM from LifeList, the project data for the network are automatically applied.

3 Configuring Networks and Devices

3.1 Configuring Networks and Devices

Networks and devices can be configured in the SIMATIC Manager. The following networks are supported:

- PROFIBUS-DP network
- PROFIBUS-PA network
- HART modem
- HART interface network
- HART multiplexer network
- SIPART-DR network
- SIREC network
- MODBUS network

Different options with the appropriate authorizations (see **Authorization Instructions**) are necessary for the different communication modes.

In **SIMATIC PDM Integrated** PROFIBUS-DP/PA networks and devices can also be configured using STEP 7 HW-Config.

Note: The networks configured in HW-Config do not appear in the SIMATIC Manager, however.

The following figures show the various network topologies of a STEP 7 project.

PROFIBUS-DP network:

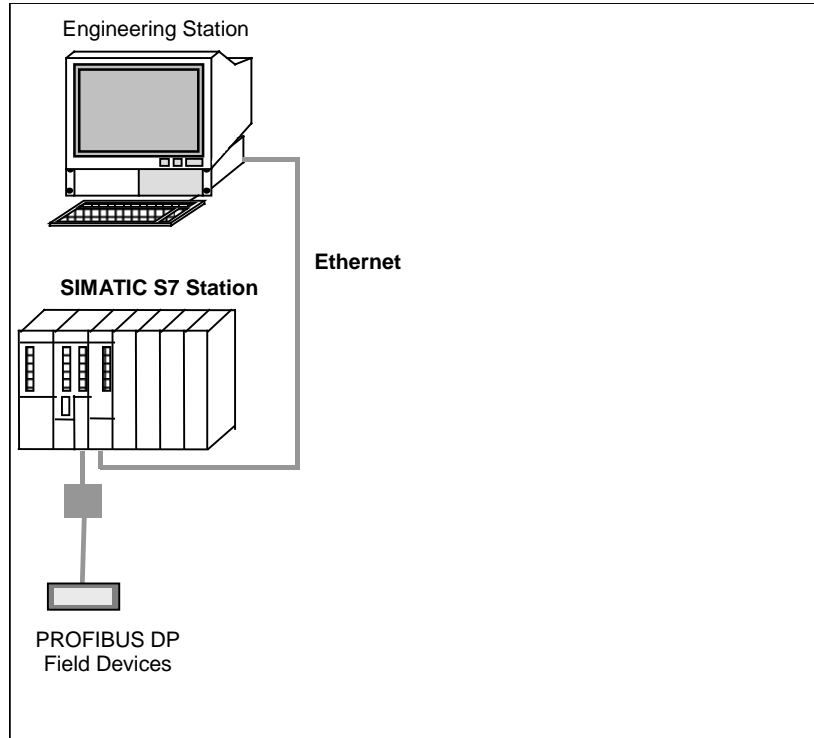

PROFIBUS-PA network:

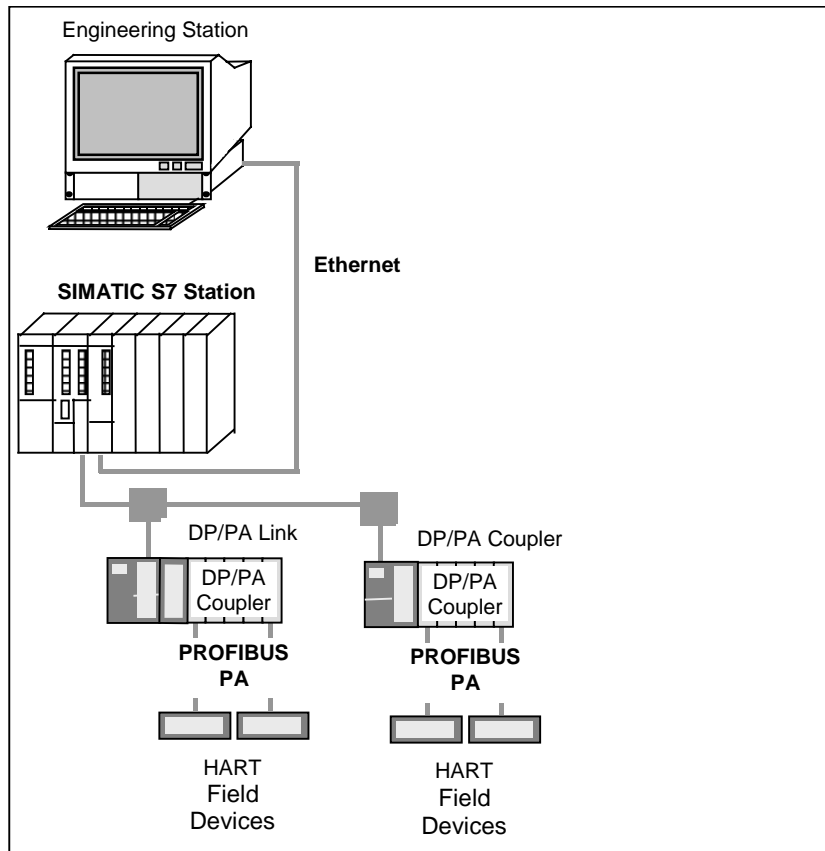

HART modem:

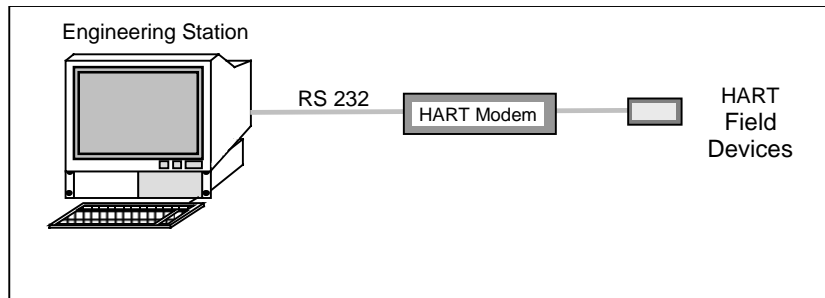

HART multiplexer network:

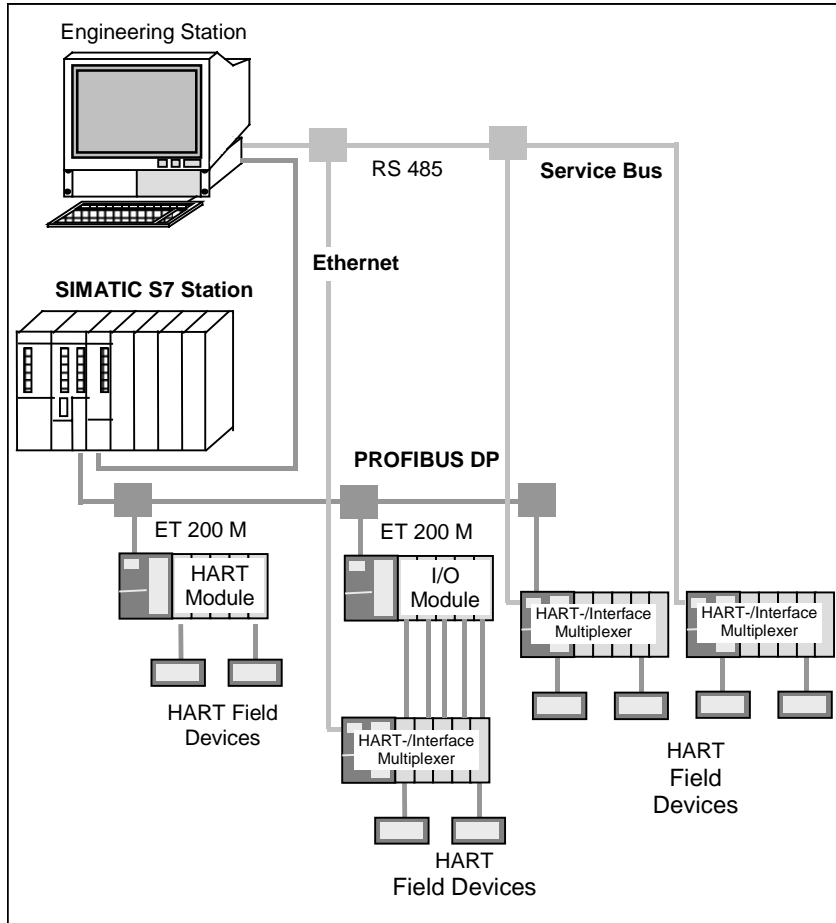

SIPART DR/SIREC/MODBUS network:

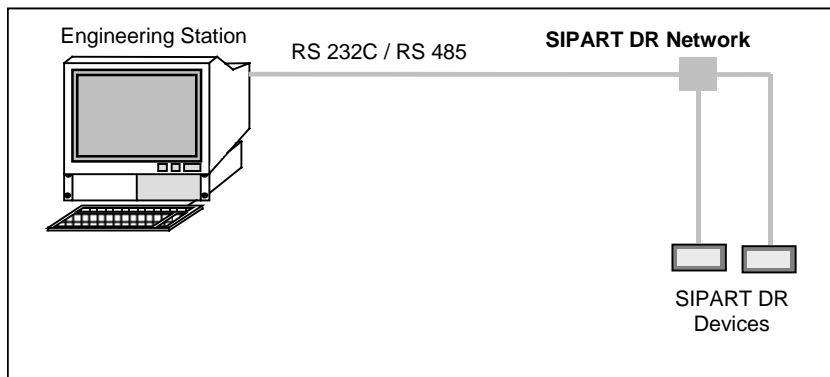

3.2 SIMATIC Manager

The SIMATIC Manager is the graphical user interface for SIMATIC users which is used to manage projects.

It is the starting user interface for configuring and programming in STEP 7. You can:

- Create projects
- Configure and parameterize hardware
- Plan and configure hardware networks
- Program blocks
- Debug and commission your programs

The access to the functionality is object-oriented, intuitive and easy to learn.

Setting the language

In order to change the language select the menu **Options > Settings...** command. The dialog box then displayed the "Language" tab card. You can adapt the language and mnemonics to your requirements on this tab card. Select the language you want to work in the "Language" field. Only the installed language is displayed for selection in the list.

For detailed information about working with the SIMATIC Manager please refer to the corresponding online help.

3.3 SIMATIC Manager Views

Component view

In addition to the familiar component view for SIMATIC S7 (where you can also switch to HW-Config in the integrated version), after SIMATIC PDM has been installed the SIMATIC Manager has two other views that can be activated under the **View** menu in the SIMATIC Manager. SIMATIC PDM can be started from all three views by double-clicking a device.

Process device network view

In the **process device network view** the devices are shown in groups according to the network topology. Devices that can be reached through several networks are shown several times accordingly. You can configure networks and devices in this view.

Process device plant view

The **process device plant view** gives an overview of all configured devices in all configured networks. This view is used to obtain a quick overview of the configured devices. New devices or networks cannot be configured in this view.

You can specify which of the three views is to be displayed when the SIMATIC Manager is started by selecting **Options > Settings > View > Preset Project View** in the SIMATIC Manager.

In the two new views you can select the view as is normal in STEP 7:

- Large icons
- Small icons
- List
- Details

In the **Details** view you can select which information is to be displayed using the **Options > Settings > Columns** menu command.

New devices that have been added in the process device network view and in HW-Config are automatically shown in the process device plant view. If a device is deleted in the network view or the HW-Config, it will still be in the plant view. It could of course still be accessible via a different network or be assigned to a network in the network view or HW-Config later.

In the plant view you can add devices which you can assign to a network at a later date. This is carried out in the network view after **Insert New Object** or in the HW-Config after the new device has been opened for the first time by using **Select** in the "Insert SIMATIC PDM Object" dialog box. Click **Select** in the network view after **Insert new object** or in HW-Config after the new device is opened for the first time in the **Insert SIMATIC PDM object** dialog box. In the subsequent **Open** dialog box select the process device plant view and then the device.

Once a link has been created, changes to the name of an object in a view are also automatically transferred to the other views.

If you work with **SIMATIC PDM Integrated**, you can configure the system with SIMATIC station(s), network(s) and PROFIBUS-DP/PA devices in HW-Config (HART modems, HART interface networks, SIPART-DR networks and the associated devices cannot be configured in HW-Config, however).

Specify the network topology in the process device network view, insert all devices configured in HW-Config and create a link to the devices in the plant view (see above). This has the following advantages:











- In the network view you can configure HART modems, HART interface networks, SIPART-DR networks and associated devices as well as modules for remote I/O systems. The network view is then complete. SIMATIC PDM can thus be started from HW-Config, the network view and the plant view.
- In this way you can also use projects which you have created with the **SIMATIC PDM Integrated** option on PCs on which only **SIMATIC PDM** is installed (without the **Integration in STEP 7/PCS 7** option).

You can configure "smaller" projects, e.g. for end-end connections between PCs and devices in the workshop, in the process device network view.

3.4 Icons for Devices

The following table explains the meaning of the icons for the devices configured in SIMATIC PDM. These icons are not completely supported by all devices. The icons are shown in the network view and the plant view of the SIMATIC Manager, in SIMATIC PDM and in LifeList.

The icons are assigned when the devices are configured. When a connection is established, device-specific diagnostic information is automatically classified and represented by the icons. This diagnostic information is automatically stored in the project, even if the configuration data is not stored there.

Icon	Communication	Device Status	Meaning
	-	-	No device type from the device catalog has been assigned to the device, or it is not activated.
	Unchecked	Unchecked	A device type from the device catalog could be assigned to the device, but there has not yet been any communication with the device.
	Fault	Unchecked	Communication could not be established, was interrupted, or no communication with the device was possible by using the configured address.
	Good	Configuration error	The device contacted is not the same as the configured device or the device configuration is incorrect (see Secure Communication).
	Good	Fault	A fault occurred in the device (e.g. HW temperature too high).
	Good	Maintenance required	Immediate maintenance required to prevent a possible device fault from occurring.
	Good	Maintenance recommended	Maintenance initial warning: maintenance should be scheduled.
	Good	Simulation or manual operation	The communication was good. The device is in simulated or manual operation.
	Good	Process error	A process error has occurred (e.g. a limit value has been exceeded).
	Good	Good	The communication and the device status were good. There are no messages.
	Good	Unchecked	The communication was good. The device does not support a diagnostic check.

3.5 SIMATIC PDM (not integrated in STEP 7/PCS 7)

SIMATIC PDM can also be executed without STEP 7/PCS 7. In this case install the SIMATIC Manager which you can select in the SIMATIC PDM Setup.

Networks and devices are configured in the process-device network view in the SIMATIC Manager.

3.6 Creating a Project in the Process Device Network View

Proceed as follows:

1. Start the SIMATIC Manager.
2. Select the **File > New** menu command and then specify the project type and enter a name for the project in the "New" dialog box which is displayed.
3. Select the **View > Process Device Network View** menu command. A Networks object is automatically created in the window in which all networks are configured.
4. Add a PC object by clicking on the Networks object with the right-hand mouse button. Select **Insert New Object > PC** in the pop-up menu which is displayed.
5. Add an interface to the PC by clicking on the PC object with the right-hand mouse button. Select **Insert New Object** in the pop-up menu that is then displayed. Select the corresponding interface type. SIMATIC PDM offers the following interface types:
 - **DP interface** (PROFIBUS DP interface via a CP module)
 - **COM interface** (serial interface via COM1, COM2).
6. You can set the **Object features** by clicking the interface you have inserted with the right mouse button. You do not have to do anything for the DP interface yet. For the COM interface specify the COM port first in the "Connecting Data" tab in the "COM Interface Properties" dialog box.
7. In order to insert the actual network click on the **Networks** object with the right mouse button and select the appropriate network type in the pop-up menu that is displayed. SIMATIC PDM offers the following networks:
 - PROFIBUS-DP network (for DP interface),
 - SIPART-DR network,
 - HART interface network
 - HART modem (for COM interface).
 - HART multiplexer network
 - SIREC network

8. Couple the previously configured interface with the newly created network by clicking it with the right mouse button. For the DP interface specify the PROFIBUS-DP network in the "Network" tab of the "DP Interface Properties" dialog box. For the COM interface specify the HART interface network, the HART modem or the SIPART-DR network in the "Network" tab of the "COM Interface Properties" dialog box.

If you want to use the project on different PCs with different hardware configurations without having to adapt the existing PC object every time, you can insert several PC objects. The PC object marked with a red icon indicates the "current" PC that is used for communication. In order to switch over to another PC configuration, right-click on the appropriate PC object and select the **Options > Define Current PC** menu command in the SIMATIC Manager.

3.7 Coupling a Device in the Process Device Network View

You can now insert devices in the network by clicking on the previously configured network with the right-hand mouse button.

PROFIBUS DP network:

- **Inserting a DP device**
PROFIBUS-DP devices can be inserted directly for the PROFIBUS-DP network. When you insert the devices, the "Insert SIMATIC PDM Object" dialog box is displayed. Enter the desired data there.
- **Inserting a DP remote I/O system (distributed periphery)**
Insert a head station first when inserting a DP remote I/O system (distributed periphery). When inserting, enter the desired data in the "Insert SIMATIC PDM Object" dialog box.
Note: For further information on particular points pertaining to the distributed periphery please refer to the section on Remote I/O Systems.
- **Inserting a PA device via DP/PA coupler**
PROFIBUS-PA devices can be inserted via a DP/PA coupler for the PROFIBUS-DP network. The insert procedure is the same as with DP devices. The DP/PA coupler need not be configured, an appropriate bus transmission rate (for example, 45.45 kbits/s for the Siemens coupler) merely needs to be set for the PROFIBUS-DP network.
- **Inserting a PA device via DP/PA link**
Insert a DP/PA link and then the PROFIBUS-PA device when inserting PROFIBUS-PA devices via a DP/PA link. Once you have inserted the DP/PA link specify the PROFIBUS address for the DP/PA link in the "Properties ... – Connecting Data" dialog box. When you insert the devices, the "Insert SIMATIC PDM Object" dialog box is displayed. Enter the desired data there.

- **Inserting a PA remote I/O system (distributed periphery)**

Insert a head station in a PROFIBUS-DP network (via DP/PA coupler, see above) or to a DP/PA link first when inserting a PA remote I/O system (distributed periphery). When inserting, specify a name and the address in the "Insert SIMATIC PDM Object" dialog box.

Note: For further information on particular points pertaining to the distributed periphery please refer to the section on Remote I/O Systems.
- **Inserting a HART device via HART module**

When inserting HART devices, first insert a remote I/O, assign a HART module to it and then assign the HART device to the module. After inserting specify the PROFIBUS address for the remote I/O and the slot for the HART module in the respective "Properties ... – Connecting Data" dialog boxes. When you insert the devices, the "Insert SIMATIC PDM Object" dialog box is displayed. Enter a name and the channel for the HART module there.
- **Inserting redundant devices**

You can create redundant configurations of PROFIBUS devices and PROFIBUS remote I/Os. To do this, insert a single device (see above) and then select one of the following options:

 - Line redundancy: Insert the previously inserted device again in the **same** PROFIBUS network. To do this, proceed as follows: In the "Insert SIMATIC PDM Object" dialog box that is displayed, click the button "Select object ..." to select the same device.
 - Application redundancy: Insert the previously inserted device again in a **different** PROFIBUS network. To do this, proceed as follows: In the "Insert SIMATIC PDM Object" dialog box that is displayed, click the button "Select object" ... to select the same device.

HART interface network:

- **Inserting a HART device**

HART devices can be inserted directly for the HART interface network. When the first HART device is inserted, a HART modem object will be automatically created and all devices configured in the HART interface network will be referred to in the HART modem object. Set the Master type (primary/secondary, as a rule secondary) in the "Properties ... – Connecting Data" dialog box for the HART interface network and the HART modem. Ensure you specify the Manufacturer, Device type and Device name in the "Properties ... – Connecting Data" dialog box for the HART device in the HART interface network because this is used to form the address information. Ensure you specify the Short address in the "Properties ... – Connecting Data" dialog box for the HART device in the HART modem.

HART modem:

- **Inserting a HART device**

You can access devices in the HART modem via the HART modem without additional configuration (in the HART interface network), for example, for commissioning.

You can insert HART devices directly for the HART modem. Set the Master type (primary/secondary, as a rule secondary) in the "Properties ... – Connecting Data" dialog box for the HART modem. Ensure you specify the Short address in the "Properties ... – Connecting Data" dialog box for the HART device in the HART modem.

HART Multiplexer Network

You can insert multiplexer networks in process device network view in the SIMATIC Manager. To do so you have to select a multiplexer network included in the HCF OPC server in the "Insert" dialog box. Then the hierarchy of the selected multiplexer is included in the SIMATIC Manager. The structure of the hierarchy differs depending on the respective multiplexer. There are one-stage multiplexers (for example, multiplexers of Measurement Technology Ltd.) and two-stage multiplexers (for example, Pepperl+Fuchs multiplexers).

SIPART-DR network:

- **Inserting a SIPART DR compact controller**

You can only insert SIPART DR compact controllers with a serial interface (RS 232C/RS 485) in the SIPART-DR network (see the detailed description Coupling a SIPART DR Controller).

Once the (terminal) devices have been inserted in the process device network view, they will also be displayed in the process device plant view.

SIREC network:

- **Inserting a SIREC process recorder**

You can only insert SIREC process recorders in the SIREC network (see the detailed description Coupling a SIREC Process Recorder).

3.8 Creating a Project in the Process Device Plant View

Proceed as follows:

1. Start the SIMATIC Manager.
2. Select the **File > New** menu command. In the subsequent "New" dialog box specify the "Project" type and enter a name for the project.
3. Select the **View > Process Device Plant View** menu command. A "Devices" object is automatically created in the window in which all devices are inserted.

3.9 Coupling a Device in the Process Device Plant View

You can now insert devices without assignment to a network by clicking on **Devices** with the right mouse button. You can insert:

- **TAG** (a TAG is a "synonym" for a device that you can insert).
- **Remote I/O** (distributed periphery). The head station of a remote I/O system is the module that will be connected to a network later on and can be connected in various modules. These modules cannot be inserted in the plant view (see chapter Remote I/O Systems).
- **Remote I/O submodule** (distributed periphery). These submodules are modules which can be later inserted subordinate to the head station of a remote I/O.

The selected object is inserted directly and only once in the plant view. The "Insert SIMATIC PDM Object" dialog box is not displayed.

3.10 Inserting Several Devices at the Same Time

In the process device network view you can use the "**Insert New Object**" menu command to insert several devices or modules into a configured network at the same time. In the "Insert SIMATIC PDM Object" dialog box you can enter or set a value from 1 to 256 under Number of "*Name*" objects. Several objects are inserted with the designation *Name 1*, *Name 2*, ... *Name n*. No specific device is assigned to these objects at first. The addresses of the objects are incremented starting with the lower value up to the highest permitted address. This address assignment may sometimes need to be corrected by the user.

The assignments are carried out for each object in turn using the **Object Properties** pop-up menu command.

- Change the name in the "General" tab card in the "Properties of *Name n*" dialog box.
- Select the "New Assignment" function in the "Device" tab card. In the subsequent "SIMATIC PDM Device Selection" dialog box select the required device as usual.
- Set the address or slot on the "Connecting Data" tab card.

3.11 Exchanging Devices

Devices can be exchanged in the process device network view and process device plant view.

When a device is exchanged in a system, there are two ways of updating the project in SIMATIC PDM:

- Delete the object of the old device and insert an object for the new device. This procedure is recommended if the devices are totally different. All settings will be lost when the object of the old device is deleted.
- Try to exchange identical devices whenever possible (e.g. same manufacturer, same type but new model) in this way you can assign the new device to the object in the "Device" tab card of the "Object Properties" dialog box, using the **New Assignment** function from the subsequent **SIMATIC PDM Device Selection** dialog box. In this case all the read-only variable settings that are in both devices will be kept. A device exchange carried out in the process device network view will be transferred to the process device plant view and vice versa.

3.12 Deleting Devices

If you delete device in SIMATIC PDM, in the process device network view or in STEP 7/PCS 7 HW-Config, only the use of this device is removed from this specific location. However, the device remains available in the process device plant view of the SIMATIC Manager. Thus, the device can still be reused. Devices have a history that is lost if they are permanently deleted. For example, devices have to be prepared in the workshop, installed in the plant and then, at times, removed to be serviced in the workshop or installed at another location. To permanently delete a device, delete it in the process device plant view of the SIMATIC Manager.

3.13 Information on Configuring and Parameterization

This section contains notes which will provide additional information in particular cases. Please See also the information in the README file. This file is installed by default under Siemens\PDM\Sim_PDM\README.wri.

1. For information on specific settings of the bus parameters by means of the **Set Programming Device/PC Interfaces** program, be sure to read the README file.
2. **PROFIBUS PA profile devices**
The parameterization and the master configuration have to be carried out separately for the cycle in the case of profile devices which can be configured in accordance with a profile, but which require an own device-specific GSD file (devices master file). For the master configuration import the device-specific GSD files in HW-Config and place these devices at the DP/PA master system from the HW-Config catalog under the directory "PROFIBUS DP/further field devices". For the parameterization insert a further SIMATIC S7 station with a DP master system. Place the devices which you want to parameterize with SIMATIC PDM at this system.
3. **Error handling of PROFIBUS PA profiles**
For some devices, you can call up the **Error Handling** dialog box in the **Options** menu. In this you can specify that certain errors which occur during downloading to the programming device/PC or to the device be ignored, so that downloading is not aborted. Any errors occurring are displayed in an error dialog box.
4. **Block configuration of HART devices**
HART devices are configured via general parameters and via parameters which are assigned to blocks. For example, some pressure transducers can measure the temperature as well. For such a device the number of blocks and the number of inputs/outputs are set to two each. SIMATIC PDM supports devices having up to 6 blocks. The number of inputs/outputs is limited to up to four by the HART definition. Inputs and outputs can be assigned to the blocks by means of the **Block assignment** on-line Dialog Box. This on-line dialog box is only supported by devices which allow an assignment of inputs/outputs to blocks.
5. The basic configuration of HART devices (in the "SIMATIC PDM device selection" dialog box reached through the menu command HART > Universal > Standard) encompasses the functional scope which is defined in the Universal Commands and the Common Practice Commands by the HCF.

3.14 PROFIBUS

3.14.1 Coupling a PROFIBUS Device in SIMATIC PDM

Proceed as follows in order to couple a PROFIBUS device (PROFIBUS-DP device, PROFIBUS-PA device or PROFIBUS remote I/O):

1. Start the SIMATIC Manager by double-clicking on the icon on the desktop or by using the Windows Start menu.
2. Select the menu command **View > Process Device Network View** to specify the process device network view.

Note

If you usually intend to work in the process device network view, select the menu command **Options > Customize**, go to the "View" tab, and select "Default project view" in the drop-down list box.

3. In order to set the programming device/PC click on the Windows command button **Start > Settings > Control Panel > Set Programming Device/PC**. If you have installed a PCMCIA card, click on the desired CP (for example, CP5511). Click on "Properties" and carry out the following settings in the displayed dialog box:
 - Enter "DP" in the "Profile" field.
 - Select the transfer rate "45.5 kbits/sec" in the "Transfer speed" field.
 - De-activate the "Does not become active as the only master" radio button.

Note: When installing the PCMCIA card ensure that you always insert the card together with the connected cable.

4. Create a new project by using the **File > New** menu command. Enter the desired project name in the displayed "New" dialog box and confirm your entries with "OK".

In order to insert the PROFIBUS device, select the "PROFIBUS DP Network" object in the right-hand window and press the right-hand mouse button. In the displayed pop-up menu select the entry **Insert New Object > PROFIBUS-DP device, PROFIBUS-PA device or Remote I/O**. Enter the name of the measuring point in the displayed dialog box.

5. If you are using a PROFIBUS-DP/PA coupler, configure the PROFIBUS-PA device directly at the PROFIBUS network or behind the PROFIBUS link. The coupler itself is not configured.

As an alternative, you can insert a PROFIBUS link (Y-link or DP/PA-link) into a PROFIBUS-DP network. You can then insert PROFIBUS devices behind the network, but you cannot insert another PROFIBUS link.

Note

The address of the PROFIBUS device that you set in the "Insert SIMATIC PDM objects(s)" dialog box can also be entered afterward in the "Object properties" dialog box ("Connection properties" tab).

6. Start SIMATIC PDM by double-clicking on the newly inserted PROFIBUS device in the right-hand window. Select the corresponding device in the menu tree (only required for the first call) and configure the device.

3.14.2 Block Structure of the PROFIBUS Profile Devices

PROFIBUS profile devices consist of three different blocks. The following diagram shows the connection between them.

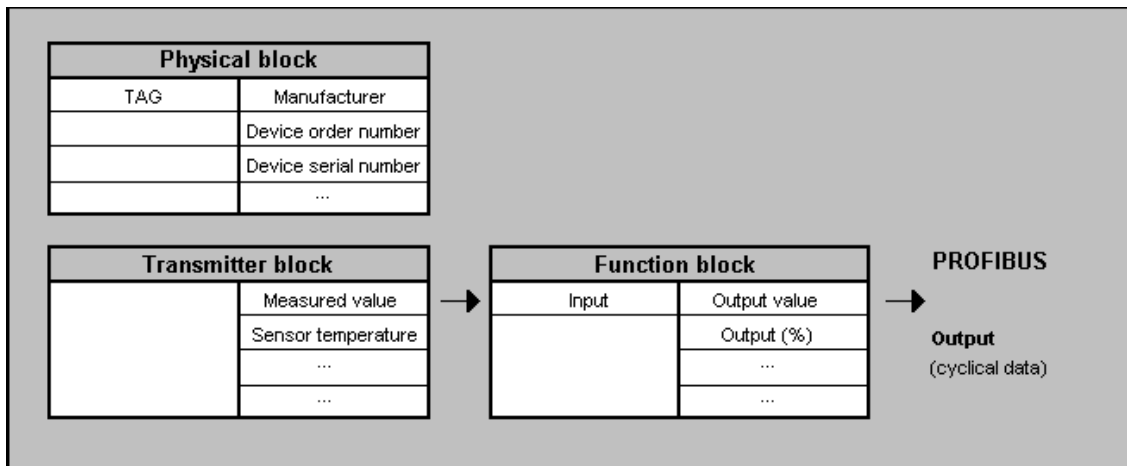

Physical block:	Contains data describing the profile device and the device status (e.g. manufacturer, device order number etc.).
Transducer block:	Contains the actual transducer functions. It supplies the measured, corrected and adjusted measured value at the output. This block also provides additional information, e.g. the sensor temperature, for some profile devices.
Function block:	Used to represent the measured value on the actual measured variable, e.g. the filling level. Set characteristic curves and attenuation are, for example, taken into consideration. The measured value is also returned as a percentage value.

3.14.3 Distributed Periphery — Remote I/O Systems

HW-Config

If you have configured remote I/O systems in HW-Config, you can open (start) SIMATIC PDM for the head station and the submodules in the detail view.

PDM is started in the context of the corresponding component. When opening SIMATIC PDM for remote I/O systems which you have configured in HW Config, automatic data synchronization is executed (from HW Config in the Network view). Messages are displayed during the synchronization if necessary. If the synchronization is faulty, the corresponding error message will be displayed upon termination.

Caution: If you delete an object in the network view, and not in HW Config, it will be reinserted during data synchronization!

Process device plant view

The head station of the remote I/O systems and the submodules of the head station are shown in the plant view and can be opened.

Process device network view

- Create an object for the head station in the network view (if you have carried out configuration in HW-Config beforehand, create a link to the corresponding object in the plant view by clicking on the "Select" command button in the "Insert SIMATIC PDM Object" dialog box).
- Then add a module object for the head station in the network view for each module fitted in the head station (see also Inserting Several Devices at the Same Time).
- Afterwards you can open the remote I/O system in the SIMATIC PDM network view. Double-click of the remote I/O or on one of the subordinate objects.
- If you are working off-line, you will now have to assign a function (according to the actual setup or configuration in HW-Config) these "empty" objects individually and manually. Open the object by selecting its symbol in the parameter group view. Then select the desired setting (*) in the parameter table for the parameter defining the function and save the object.

- If you can work online, select the head station object and select the "**Device > Complete Upload to the Programming Device/PC**" function from the menu bar. The parameters for the slot (*) function settings are updated and at the same time the functions are assigned to the modules in accordance with the slot assignments.
(*) The names of these parameters and their possible settings are different according to the remote I/O system.

Note:

In HW-Config you can open SIMATIC PDM for the head stations as usual by double-clicking on the icon. In the process device network view and in the process device plant view you can open SIMATIC PDM for the head station and the modules by using the **Open** pop-up menu command.

3.15 HART

3.15.1 Coupling a HART Device to a HART Modem in SIMATIC PDM

Proceed as follows in order to couple a HART device to a HART modem:

1. Start the SIMATIC Manager by double-clicking on the icon on the desktop or by using the Windows Start menu.
2. Select the menu command **View > Process Device Network View** to specify the process device network view.

Note

If you usually intend to work in the process device network view, select the menu command **Options > Customize**, go to the "View" tab, and select "Default project view" in the drop-down list box.

3. Create a new project by using the **File > New** menu command. Enter the desired project name in the displayed "New" dialog box and confirm your entries with "OK".
4. In order to insert a HART network double-click on the "Networks" object in the right-hand window. Select "Networks" in the left-hand window and press the right-hand mouse button. In the displayed pop-up menu select the entry **Insert New Object > HART Modem Network**.
5. In order to check whether the correct network and the correct port are assigned to the COM interface, double-click on the "PC" object in the right-hand window. Select the "COM interface" object and press the right-hand mouse button. Select the **Object Properties...** entry in the displayed pop-up menu. In the displayed "Properties" dialog box set the HART modem network in the "Network" tab card. If necessary, enter the desired COM port in the "Connection Data" tab card.
Note: The COM port is almost always "1" for notebooks. Since most PCs have two COM interfaces, you always have to specify which interface the HART modem is connected to in this tab card.
6. In order to insert the HART device select the "HART modem network " object in the right-hand window and press the right-hand mouse button. In the displayed pop-up menu select the entry **Insert New Object > HART Device**. Enter the name of the HART device in the displayed dialog box.
7. In order to set the device address select the inserted HART device in the right-hand window and press the right-hand mouse button. Select the **Object Properties** entry in the displayed pop-up menu. In the displayed dialog box select the "Connection Data" tab card and enter the short address.
Note: The address has to correspond to the connected device. The short address at HART devices is always "0" unless the device is in the multi-drop function.

8. Start SIMATIC PDM by double-clicking on the newly inserted HART device in the right-hand window. Select the corresponding device in the menu tree (only required for the first call) and configure the device.

Note

If there are several PCs in your project, you have to define one of them as the "current" one. To do this, select the desired "PC" object in the left window, and then select the menu command **Options > Define Current PC**.

3.15.2 Coupling a HART Multiplexer Network

You can insert multiplexer networks in process device network view in the SIMATIC Manager. Prerequisite is that a HCF-OPC Server has been installed on the computer. To do so you have to select a multiplexer network included beforehand in the HCF OPC Server in the "Insert" dialog box. Then the hierarchy of the selected multiplexer is included in the SIMATIC Manager. The structure of the hierarchy differs depending on the respective multiplexer. There are one-stage multiplexers (for example, P+F multiplexers) and two-stage multiplexers (for example, MTL multiplexers).

When a device is opened the identification can be read from the device and the correct Device Description can be assigned.

The HCF-OPC Server does not support multimaster operation. Jobs have to be coordinated in order to avoid conflicts. The coordination has to be carried out on the multiplexer network level.

Multiplexers from a vast range of companies can be addressed through this HCF-OPC server. Further information is available from the specific manufacturers or the HART Communication Foundation.

You have to use the HCF-OPC Server application in order to build up and manage the project. Detailed information on the HART Server can be found in the description or the online help of this product.

One-stage multiplexer (example: Pepperl+Fuchs)

Proceed as follows in order to couple a Pepperl+Fuchs multiplexer:

1. Select the **File > New** menu command in the SIMATIC Manager and enter a name for your project in the displayed dialog box.
2. Change to the process device network view (**View > Process Device Network View** menu command). If you already want to insert a multiplexer network at this point via the **Insert New Object > HART Multiplexer Network** pop-up menu command, the HART Server is started automatically, but the data for configuring the network are not available yet.
3. Start the HCF-OPC Server by double-clicking on the icon on the desktop or by using the **Start >...** command button in Windows.
4. Enter a name for the HART Server project in the displayed dialog box.
5. Select the project, press the right-hand mouse button and select the entry **Add Network**. Select the suitable network type (as a rule RS 485) in the displayed dialog box. Enter a name in the "Network Properties" field (this is very important since the SIMATIC Manager later uses this name to identify the network). Set the properties of the interface under "Properties" and confirm your entries with "OK". The network has now been inserted into your project.
6. You can either read in the data automatically or also set them manually.
 - **Automatic reading in:** Read in all the data (multiplexer and devices) via the **File > Learn** menu command. The configuration can only be read in online. The learning process of the data is displayed in a dialog box. While checking the addresses (multiplexer, etc.) the status of all the occupied addresses changes from "not responding" to "responding". If this is not the case, there is a connection error, for example incorrect polarity.
 - **Manual setting:** If you want to create the configuration manually, select the project, press the right-hand mouse button, select the **Add Multiplexer** entry and enter the required information in the dialog box. Then select the multiplexer, press the right-hand mouse button, select the **Add Instrument** entry and enter the required information in the dialog box. Continue by this method until all the required devices have been configured.

The following figure shows a HART Server project after the learning process for a Pepperl+Fuchs-multiplexer:

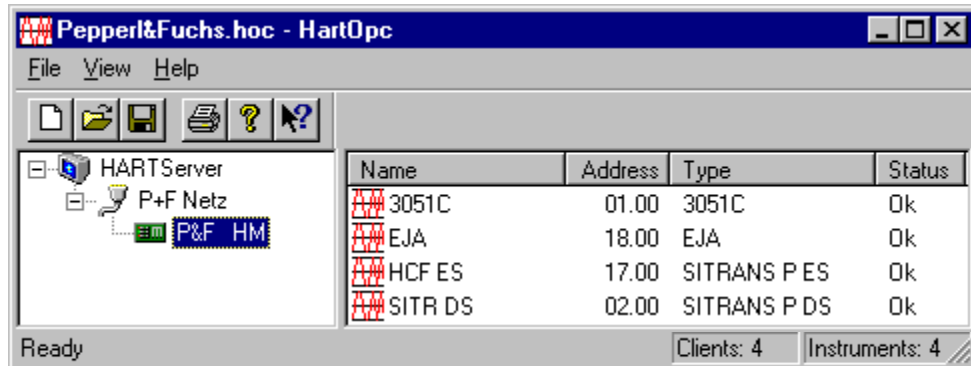

7. Now select the **Insert New Object > HART Multiplexer Network** pop-up menu command in the SIMATIC Manager.
8. In the displayed dialog box select the network name assigned by you (refer to Point 4). If you activate the option "Automatic Configuration of the Subnets", all the devices recognized in the HART Server as well as a HART modem are included automatically in the project. If you do not activate "Automatic Device Recognition during Reading In", you now have to select the individual devices from the device catalog. If the device recognition is activated, an automatic assignment is carried out in accordance with the following rules:
 - Highest priority for fully integrated devices
 - HCF devices
 - If no corresponding device is found, a universal DDL is assigned
9. Edit the individual devices in the SIMATIC Manager.

Two-stage multiplexer (example: MTL)

Proceed as follows in order to couple an MTL multiplexer:

1. Select the **File > New** menu command in the SIMATIC Manager and enter a name for your project in the displayed dialog box.
2. Change to the process device network view (**View > Process Device Network View** menu command). If you already want to insert a multiplexer network at this point via the **Insert New Object > HART Multiplexer Network** pop-up menu command, the HART Server is started automatically, but the data for configuring the network are not available yet.
3. Start the HCF-OPC Server by double-clicking on the icon on the desktop or by using the **Start >...** command button in Windows.
4. Enter a name for the HART Server project in the displayed dialog box.

5. Select the project, press the right-hand mouse button and select the entry **Add Network**. Select the suitable network type (as a rule RS 485) in the displayed dialog box. Enter a name in the "Network Properties" field (this is very important since the SIMATIC Manager later uses this name to identify the network). Set the properties of the interface under "Properties" and confirm your entries with "OK". The network has now been inserted into your project.
6. You can either read in the data automatically or also set them manually.
 - **Automatic reading in:** Read in all the data (multiplexer and devices) via the **File > Learn** menu command. The configuration can only be read in online. The learning process of the data is displayed in a dialog box. While checking the addresses (multiplexer, etc.) the status of all the occupied addresses changes from "not responding" to "responding". If this is not the case, there is a connection error, for example incorrect polarity.
 - **Manual setting:** If you want to create the configuration manually, select the project, press the right-hand mouse button, select the **Add Multiplexer** entry and enter the required information in the dialog box. Then select the multiplexer, press the right-hand mouse button, select the **Add Panel** entry and enter the required information in the dialog box. Now select a panel, press the right-hand mouse button, select the **Add Instrument** entry and enter the required information in the dialog box. Continue by this method until all the required devices have been configured.

The following figure shows a HART Server project after the learning process for a MTL multiplexer:

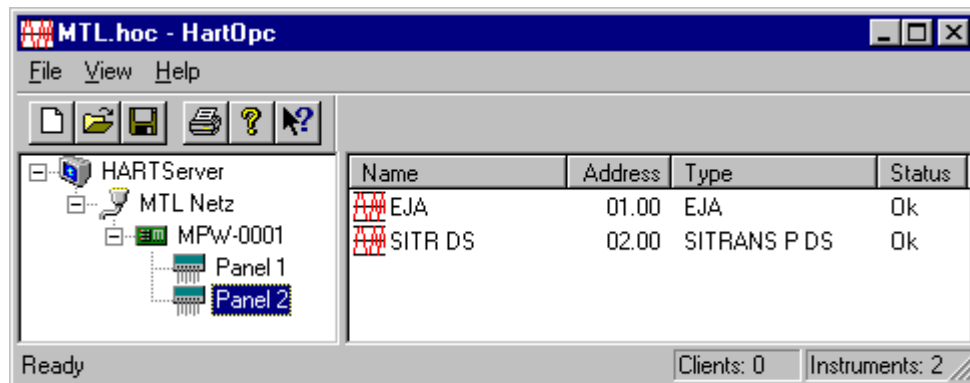

7. Now select the **Insert New Object > HART Multiplexer Network** pop-up menu command in the SIMATIC Manager.
8. In the displayed dialog box select the network name assigned by you (refer to Point 4). If you activate the option "Automatic Configuration of the Subnets", all the devices recognized in the HART Server as well as a HART modem are included automatically in the project. If you do not activate "Automatic Device Recognition during Reading In", you now have to select the individual devices from the device catalog. If the device recognition is activated, an automatic assignment is carried out in accordance with the following rules:
 - Highest priority for fully integrated devices
 - HCF devices
 - If no corresponding device is found, a universal DDL is assigned
9. The hierarchy of the multiplexer network is now displayed in the process device network view of the SIMATIC Manager.
Note: Only those panels are displayed to which devices are connected!

Learning process

You can carry out the learning process in a HART Server project on every level. If, for example, you select the project, you start the learning process for the complete configuration tree. If you select a panel, you start the process for the selected partial configuration, meaning for the instruments below the panel level.

Changing the configuration

If you change an existing multiplexer network, for example insert new devices or exchange devices (do not forget to reconfigure in the HART Server), you can use the **Edit > Compare** menu command in the SIMATIC Manager to carry out a comparison in the HCF-OPC Server. The comparison function takes the following into consideration:

- New hierarchy and devices are inserted.
- Hierarchies and devices that no longer exist are de-activated (grayed-out display in the SIMATIC Manager and the "Object activated" option in the "Properties" dialog box is not selected).

3.15.3 Coupling HART Devices via HCF-DDs

Insert a HART device in the process device network view or in HW-Config. If the program is being opened for the first time, the "SIMATIC PDM Device Selection" dialog box is displayed. In this dialog box click on the "Import catalog ..." command button once and select the HCF-DD directory on the SIMATIC PDM CD. The current HCF-DD library is contained on the SIMATIC PDM CD. Importing this library will add the HART devices that are also supported by the handheld communicator to the device catalog. **No guarantee claims or liability for damages resulting from use will be accepted for these devices.** If you want to use such a device, please consult the device manufacturer. The manufacturer should check whether the device works with SIMATIC PDM and then contact us.

The HCF catalog is sorted according to manufacturer, device type and device revision with assigned DD revision. If you are not familiar with these data, in particular the device revision, first select **Standard HART device** (universal standard) in the **SIMATIC PDM device selection – HART device catalog** dialog box. This standard can be used to read basic information from the device including the manufacturer, device type and device revision. You can then assign the correct device from the HCF catalog to the HART device object (see Exchanging Devices).

3.16 SIPART

3.16.1 Coupling a SIPART DR Device to an RS 232C/RS 485 in SIMATIC PDM

Proceed as follows in order to couple a SIPART DR device to an RS 232/RS 485:

1. Start the SIMATIC Manager by double-clicking on the icon on the desktop or by using the Windows Start menu.
2. Select the menu command **View > Process Device Network View** to specify the process device network view.

Note

If you usually intend to work in the process device network view, select the menu command **Options > Customize**, go to the "View" tab, and select "Default project view" in the drop-down list box.

3. Create a new project by using the **File > New** menu command. Enter the desired project name in the displayed "New" dialog box and confirm your entries with "OK".
4. In order to insert a SIPART-DR network double-click on the "Networks" object in the right-hand window. Select "Networks" in the left-hand window and press the right-hand mouse button. In the displayed pop-up menu select the entry **Insert New Object > SIPART DR-Network**. Select "SIPART DR Network", press the right-hand mouse button and select the **Object Properties...** entry in the displayed pop-up menu. The settings in the "Connection data" tab card must agree with the settings of the device.
5. In order to check whether the correct network and the correct port are assigned to the COM interface, double-click on the "PC" object in the right-hand window. Select the "COM interface" object and press the right-hand mouse button. Select the **Object Properties...** entry in the displayed pop-up menu. In the displayed "Properties" dialog box set the SIPART DP network in the "Network" tab card. If necessary, enter the desired COM port in the "Connection Data" tab card.
Note: The COM port is almost always "1" for notebooks. Since most PCs have two COM interfaces, you always have to specify which interface the device is connected to in this tab card.
6. In order to insert the SIPART DR device select the "SIPART DR Network" object in the right-hand window and press the right-hand mouse button. In the displayed pop-up menu select the entry **Insert New Object > SIPART DR Device**. Enter the name of the measuring point in the displayed dialog box.

7. In order to set the device address select the inserted SIPART DR device in the right-hand window and press the right-hand mouse button. Select the **Object Properties** entry in the displayed pop-up menu. In the displayed dialog box select the "Connection Data" tab card and enter the station number.
Note: The station number has to correspond to the connected device (0 - 31).
8. Start SIMATIC PDM by double-clicking on the newly inserted SIPART DR device in the right-hand window. Select the corresponding device in the menu tree (only required for the first call) and configure the device.

Note

If there are several PCs in your project, you have to define one of them as the "current" one. To do this, select the desired "PC" object in the left window, and then select the menu command **Options > Define Current PC**.

3.16.2 Coupling a SIPART DR Controller

The compact controllers SIPART DR19, DR19P, DR20, DR21, DR22 and DR2210 can be optionally equipped with a communication module for PROFIBUS DP communication or for serial communication using RS 232C/RS 485. In both cases defined settings must be made on the controller. These settings must correspond with the settings in SIMATIC PDM! Consult the corresponding device manual about use of the controller.

Function	Required settings		Number of the structure switch S.. with SIPART DR.. controller			
	PROFI-BUS DP	RS 232C / RS 485	DR19 DR19P	DR20	DR21	DR22 DR2210
Serial interface	1	1	S92	---	S84	---
Data transmission	>0	>0	S93	S42	S85	S101
Transmission rates	0	Any	S94	S43	S86	S102
Vertical parity	0	Any	S95	S44	S87	S103
Longitudinal parity position	0	Any	S96	S45	S88	S104
Longitudinal parity	0	Any	S97	S46	S89	S105
Station number	0 to 125 ^{*,**)}	0 to 31	S98	S47 ¹⁾	S90	S106
Time monitoring CB	OFF, ≤ 10 s	OFF	S99	S48	S91	S107

^{*)} Station number with DR20 and PROFIBUS DP only 0 to 31

^{**)} See note for PROFIBUS DP communication

The SIPART DR controllers are configured in the same way as described for other devices in the topics SIMATIC PDM Integrated or SIMATIC PDM (without HW-Config) with the following additional conditions:

PROFIBUS DP Communication

The SIPART DR controllers with a PROFIBUS DP module can be inserted as DP devices in HW-Config or directly for a PROFIBUS-DP network in the Process device network view. The "Select the Nominal Configuration" dialog box which is displayed during configuration in HW-Config has no significance for SIMATIC PDM, but is important for the cyclic communication (master classes). Confirm this dialog box with "OK".

Ensure you enter the address which must correspond with the station number (see table) set on the SIPART DR controller in the corresponding "Properties ..." dialog box.

Notes:

- Please note that the PROFIBUS-DP master also has an address (standard 0 ... 3). Therefore assign addresses which will not cause a conflict with the master address to the controller.
 - Do not select SIPART DRxx in the HW-Config hardware catalog. This is an object that cannot be used by SIMATIC PDM.
-

Serial Communication (RS 232C/RS 485)

The SIPART DR controllers with an RS 232 C/RS 485 module can be inserted as devices directly for a SIPART-DR network in the **Process device network view**.

Enter the data corresponding with the settings on the controller for the SIPART-DR network in the "Properties ... > Connecting data" dialog box (see table).

Ensure you enter the address/station number for the SIPART DR device which must correspond with the station number (see table) set on the SIPART DR controller in the "Insert SIMATIC PDM Object" dialog box.

Please refer to the SIPART DR controller device manuals for special hardware conditions (connector pin assignment, operation with bus driver etc.).

3.17 SIREC

3.17.1 Coupling a SIREC Network

Proceed as follows in order to couple a SIREC network:

1. Start the SIMATIC Manager by double-clicking on the icon on the desktop or by using the Windows Start menu.
2. Select the menu command **View > Process Device Network View** to specify the process device network view.

Note

If you usually intend to work in the process device network view, select the menu command **Options > Customize**, go to the "View" tab, and select "Default project view" in the drop-down list box.

3. Create a new project by using the **File > New** menu command. Enter the desired project name in the displayed "New" dialog box and confirm your entries with "OK".
4. In order to insert a SIREC network, double-click on the "Networks" object in the right-hand window. Select the "Networks" object in the left-hand window and press the right-hand mouse button. In the displayed pop-up menu, select the entry **Insert New Object > SIREC Network**.
5. In order to insert the SIREC device, select the "SIREC Network" object in the right-hand window and press the right-hand mouse button. In the displayed pop-up menu, select the entry **Insert New Object > SIREC Device**. In the menu tree, select the appropriate device (only required for the first call). In the dialog box displayed, enter the name of the device and confirm your entries with "OK".
6. In order to check whether the correct network and the correct port are assigned to the COM interface, double-click on the "PC" object in the right-hand window. Select the "COM interface" object and press the right-hand mouse button. In the displayed pop-up menu, select the **Object Properties** entry. In the displayed "Properties" dialog box, set the SIREC network in the "Network" tab card. If necessary, enter the desired COM port in the "Connection Data" tab card.
Note: The COM port is almost always "1" for notebooks. Since most PCs have two COM interfaces, you always have to specify which interface the device is connected to in this tab card.
7. In order to set the device address, select the inserted SIREC device in the right-hand window and press the right-hand mouse button. In the displayed pop-up menu, select the **Object Properties** entry. In the displayed dialog box, select the "Connection Data" tab card and enter the settings required for communication.
Note: The station number has to correspond to the connected device.

8. Start SIMATIC PDM by double-clicking on the newly inserted SIREC device in the right-hand window and configure the device.

Note

If there are several PCs in your project, you have to define one of them as the "current" one. To do this, select the desired "PC" object in the left window, and then select the menu command **Options > Define Current PC**.

3.17.2 Coupling a SIREC Process Recorder

To be able to communicate with you device, you have to configure the interface to your process recorder as specified below:

SIREC L/LA, SIREC P/PA

No setting at the device are required.

SIREC PU

Delay time	0.50s
Response time	0.15s

SIREC VARIOGRAPH

Address	<i>(according to Station number)</i>
Serial standard	RS485 20mA <i>(for RS232 communication)</i>
Procedure	ETX-ACK/NAK
Baud rate	<i>(according to SIREC NET)</i>
Frame	8D-1S, even
Block length	250
Delay time	0.00s
Response time	0.15s
Format	<i>(not relevant)</i>
Talk Only	<i>(not relevant)</i>
Listen Only	<i>(not relevant)</i>
Mode	Manual/remote control

3.18 MODBUS

3.18.1 Coupling a MODBUS Network

Proceed as follows in order to couple a MODBUS network:

1. Start the SIMATIC Manager by double-clicking on the icon on the desktop or by using the Windows Start menu.
2. Select the **View > Process Device Network View** menu command to specify the process device network view.

Note

If you usually intend to work in the process device network view, select the menu command **Options > Customize**, go to the "View" tab, and select the "Default project view" in the drop-down list box.

3. Create a new project by using the **File > New** menu command. Enter the desired project name in the displayed "New" dialog box and confirm your entries with "OK".
4. In order to insert a MODBUS network, double-click on the "Networks" object in the right-hand window. Select the "Networks" object in the left-hand window and press the right-hand mouse button. In the displayed pop-up menu, select the entry **Insert New Object > MODBUS Network**.
5. In order to insert the MODBUS device, select the "MODBUS Network" object in the right-hand window and press the right-hand mouse button. In the displayed pop-up menu, select the entry **Insert New Object > MODBUS Network**. In the menu tree, select the appropriate device (only required for the first call). In the dialog box displayed, enter the name of the device and confirm your entries with "OK".
6. In order to check whether the correct network and the correct port are assigned to the COM interface, double-click on the "PC" object in the right-hand window. Select the "COM interface" object and press the right-hand mouse button. In the displayed pop-up menu, select the **Object Properties ...** entry. In the displayed "Properties" dialog box, set the MODBUS network in the "Network" tab card. If necessary, enter the desired COM port in the "Connection Data" tab card.
Note: The COM port is almost always "1" for notebooks. Since most PCs have two COM interfaces, you always have to specify which interface the device is connected to in this tab card.

7. In order to set the device address, select the inserted MODBUS device in the right-hand window and press the right-hand mouse button. In the displayed pop-up menu, select the **Object Properties** entry. In the displayed dialog box, select the "Connection Data" tab card and enter the settings required for communication.
Note: The station number has to correspond to the connected device.
8. Start SIMATIC PDM by double-clicking on the newly inserted MODBUS device in the right-hand window and then configure the device.

Note

If there are several PCs in your project, you have to define one of them as the "current" one. To do this, select the desired "PC" object in the left window, and then select the menu command **Options > Define Current PC**.

4 SIMATIC PDM Integrated

The coupling of SIMATIC PDM with SIMATIC STEP 7/PCS 7 is described below using examples. Confirmation of dialog boxes with "OK" is not described explicitly.

After installation of SIMATIC PDM, STEP 7 re-creates its database and the hardware catalog.

Always observe the Notes on configuring and parameterization.

4.1 Creating a STEP 7 Project and Starting HW Config

Proceed as follows:

1. Start the SIMATIC Manager.
2. Select the **File > New** menu command and then specify the **Project** type and enter a Name for the project in the "New" dialog box that is then displayed.
3. If necessary, switch to the Component view. Right-click the icon with the name of your project and then select the **Insert new object** menu command, for example **SIMATIC 400 Station**.
4. Click the icon with the name SIMATIC 400 Station with the right-hand mouse button and select the **Open object** menu command. You then switch to **HW Config** (Hardware Configuration).
5. Select the **Insert > Hardware components** menu command to display the hardware catalog. Double-click on the **SIMATIC 400** icon.
6. First select a module rack, e.g. **CR2** from the list displayed under **RACK-400** and pull it into the top part of the window with the drag-and-drop function of the mouse.
7. Select a power supply, e.g. **PS-405 20A**, under **PS-400**. Place this in the first slot on the rack (see point 6).
8. Select a central processing unit, e.g. **CPU 414-2 DP** under **CPU-400** (DP means additional PROFIBUS-DP interface!). Place this in the next slot on the module rack. Select a network connection in the subsequent dialog box.
Note: Not every CPU supports the necessary bus transmission rates. The bus transmission rates must be selected to suit the coupler used. When using Siemens DP/PA couplers, ensure that the CPU supports the necessary bus transmission rate of 45.45 kbits/s.
9. Insert devices as described in "Coupling a Device in HW-Config".
10. Save the project with **Station > Save**.

4.2 Opening an Existing STEP 7 Project and Starting HW-Config

Proceed as follows to couple a device in an existing project in HW-Config:

1. Start the SIMATIC Manager.
2. Load the project with the **File > Open** menu command.
3. If necessary, switch to the **Component view**. Right-click the icon with the name SIMATIC 400-Station and select the **Open object** menu command. You then switch to HW-Config (Hardware Configuration).
4. Insert devices as described in "Coupling a Device in HW-Config".
5. Save the project with the **Station > Save** menu command.

4.3 Coupling a Device in HW-Config

Devices can be coupled in HW-Config as follows:

- **Inserting a DP device**
PROFIBUS-DP devices can be inserted directly in the PROFIBUS-DP master system.
Select the device you require under "PROFIBUS DP" from the hardware catalog and drag-and-drop it into the DP master system. If the DP master system is not displayed, select the **Insert > DP Master System** menu command in HW-Config.
- **Inserting a DP remote I/O system** (distributed periphery)
Example: ET 200iS
Place the head station **IM151-2** from the HW-Config catalog under "PROFIBUS DP\ET200iS" in the DP master system.
The slots of the head station are displayed in the detail view (table below the graphic). Place the power supply module "PS" from the HW-Config catalog under "PROFIBUS DP\ET200iS\IM151-2\PS" in slot 1. You can insert the required analog and digital modules in slot 4 or higher.
- **Inserting a PA device via DP/PA coupler**
Select a PROFIBUS-PA device in the HW-Config catalog, e.g. a SITRANS P pressure transducer, under "PROFIBUS-PA\Siemens\Sensors\Pressure\SITRANS-P" or a device profile under "PROFIBUS-PA\Others" and place it in the PROFIBUS-DP master system.
Note: The DP/PA coupler need not be configured, an appropriate bus transmission rate (for example, 45.45 kbits/s for the Siemens coupler) merely needs to be set for the DP master system.
- **Inserting a PA device via DP/PA link**
Place the **IM157** from the HW-Config catalog under "PROFIBUS-DP\DP/PA-Link" in the DP master system. HW-Config creates a PA master system for the DP/PA link. You can place PA devices there as described above.

- Inserting a PA remote I/O system (distributed periphery)**
Example Pepperl + Fuchs
 Place the head station **RSD-GW-EX1.PA** from the HW-Config catalog under "PROFIBUS-PA\I/O SYSTEM" in the DP master system (with DP/PA coupler, see above) or in the PA master system (with DP/PA link, see above). The slots of the head station are displayed in the detail view (table below the graphic). Place one of the listed **modules** from the HW-Config catalog under "PROFIBUS-PA\I/O SYSTEM\RSD-GW-EX1.PA" in a free slot.
- Inserting a HART device via an ET 200M HART module**
 Place an **IM153-2** from the HW-Config catalog under "PROFIBUS-DP\ET200M" in the DP master system. The slots of the ET 200 M are displayed in the detail view (table below the graphic). Place a HART module '**SM331 AI 2_0/4 to 20 mA HART Ex**' from the HW-Config catalog under 'PROFIBUS-DP\ET200M\IM153-2\AI-300' in a free slot. The HART module with 2 channels is shown in the detail view. Place the object listed under '..\AI-300\SM331 AI 2_0/4 to 20 mA HART Ex\HART_field_device' there.
- Inserting a HART device via an ET 200iS HART MODULE**
 Place an IM 151-2 in the DP master system from the HW Config catalog under "PROFIBUS DP\ET200iS". The slots of the ET200iS are displayed in the detail view (table below the graphic). Place a HART module "**2 AI HART**" (for HART sensors) or "**2 AO-HART**" (for HART Actors) from the HW-Config catalog under "PROFIBUS DP\ET200iS\IM151-2" in a free slot. Then open SIMATIC PDM by double-clicking on the header module, and configure the ET200iS. Close SIMATIC PDM, switch to the process device net view of the SIMATIC Manager, and configure the HART device for the ET 200iS modules.
- Enter a **PROFIBUS address** for all devices/modules connected directly to the bus in the **Properties dialog box > General > Users > PROFIBUS** (HW-Config automatically assigns addresses in the order that objects are created - these may need to be corrected, depending on the device used (refer to the device description)). Right-click on the object to reach the "Properties" dialog box.
 Addresses (address/slot/channel) issued by HW-Config for subsequent devices/modules (e.g. for modules in head stations) should not be changed if possible.
- Save the project with the **Station > Save** menu command.

Note:

The devices for cyclic communication are configured in the HW-Config device catalog so that the number of values to be communicated has to be selected additionally.

5 Working with SIMATIC PDM

5.1 How SIMATIC PDM Works

After you have opened a device from the SIMATIC Manager or from HW-Config, the parameters with their values from the project that is saved on a hard disk are displayed in a table of the user interface of SIMATIC PDM. The **Device > Download to Programming Device/PC** menu command is used to read the parameters from the device into this table.

All configurable objects, including the subordinate objects are displayed in the parameter group view. First, only the root object is displayed in the parameter table and can be edited (white background). You can set display and other options for the parameter table in the "Table". To do this, select the menu command **Options > Customize**.

If you click on one of the subordinate objects in the parameter group view, the parameters in the parameter table are displayed and can be edited.

If a object is already open by another user, a message will be displayed as to which user or PC opened the object. All fields of the parameter table have gray backgrounds, and the parameters cannot be modified.

If you make changes to the parameters of an object and save them, the parameters in applications in which the same objects are write-only opened are automatically updated. The write permission for the objects remain unchanged until you close SIMATIC PDM.

Caution

Although the SIMATIC Manager does save each individual change immediately, please be aware that **all** changes in an open SIMATIC PDM object take effect only after you have selected the menu command **File > Save**.

Several dialog boxes may be displayed simultaneously. This means that you can open the process values dialog for several objects without having to close the dialog boxes, for example. In this way you can compare the process values of two objects. In the title line of the dialog box you can see the name of the object.

The display in the status bar and the title line depends on which object you have selected.

The menu command in the **Device** menu and in the **Display** menu open online dialog boxes that display the parameters from the device and allow inputs. These dialog boxes are marked with "Online" in the title bar. Dynamic device information that is updated cyclically is displayed in them.

Configuration

You have the following possibilities of configuring devices:

- **Local configuration**
The **Device > Upload to the PC/Programming Device** menu command is used to upload the current data of the device to your programming device/PC. Change the desired parameters and download the data back to the device with the **Device > Download to the Devices** menu command.
- **Online configuration**
The "Online configuration" is not available at every device. It has to be supported by the Device Description of the device and you have to activate the "Online Dialog Box Available in the Table" option in the "Table" tab card (Options > Settings... menu command). After this function has been selected, a dialog box with the current parameter value from the device is displayed. In this dialog box you can change the parameter and write it individually directly into the device. The values from the device and the entries in the online dialog box are **not** imported into the parameter table.

Curve diagrams

At some devices curve diagrams are included in the application. x-t or x-y formats are displayed. The following operations are possible:

- The corresponding axis can be stretched or compressed by pressing the left-hand mouse button. The left-hand or upper scale value remains unchanged.
- The corresponding axis can be stretched or compressed by pressing the right-hand mouse button. The right-hand or lower scale value remains unchanged.
- The corresponding axis range can be moved by pressing the right-hand and left-hand mouse button simultaneously.

Example projects are contained on the SIMATIC PDM CD.

5.2 First Steps with SIMATIC PDM

SIMATIC PDM is easy to use and enables a quick introduction to configuration of a device.

After configuration (see **Configuring Networks and Devices**) start SIMATIC PDM by double-clicking the device icon (in SIMATIC Manager or in HW-Config).

When SIMATIC PDM is started you will see a welcoming picture and the "User" dialog box (which can be disabled) is displayed. The PDM main frame then opens. It consists of:

- Title bar
- Menu bar
- Toolbar
- Parameter group overview (on the left in the working window)
- Parameter table (on the right in the working window)
- Status bar

The **toolbar** provides icons for fast operation of functions that are also contained in the main menu.

There are different ways to select some functions, for example:

- With menu commands,
- Open a menu with the keyboard and mouse,
- Select and execute a menu command with the keyboard and mouse,
- With the mouse by clicking on icons.

The **parameter group overview** shows a directory structure in a tree as in the Windows Explorer. Depending on the selected parameter group, the appropriate parameters are displayed in the parameter table.

In the **parameter table** you can enter or select the values in the value field for input parameters (parameters with "Values" field with a white background). Inputs and changes are only effective off-line at first; the complete parameter record must be clearly transferred to the device in order to become effective there (exception parameterization via online dialog boxes; see Parameter table – Functions of the right-hand mouse button).

Note

Please refer to the manufacturer's technical manual for information on how to set the device parameters.

The **status bar** shows, among other things, whether there is an online connection to the device.

The **Options > Settings** menu command is used to carry out various individual settings for using SIMATIC PDM:

- User (access authorization)
- Password
- Table options
- Font
- Communication options
- Log tool

User settings

SIMATIC PDM has two different access authorizations for users:

- Maintenance engineers and
- Specialists

The maintenance engineers can only modify the operating data – the specialists all the data.

Setting the password

After the installation an "empty" password is preset (there is thus no formal password). In order to obtain security the specialist should assign a password.

Table options

SIMATIC PDM shows an overview of all the device parameters in a table. The behavior after an input and the layout in the display and during printing can be set here.

Setting the font

Here you can set the font used for the display and for printing the table.

Communication options

After the installation the cycle time for periodic communication jobs is set to 1,000 ms (corresponding to 1 s). You can change this value, but should not reduce it too far unnecessarily.

Log tool

SIMATIC PDM offers an integrated log tool, for example to help in searching for errors during communication problems. You can activate it and determine which log messages are to be output. If you activate the log tool, a window with the most important log messages is displayed while SIMATIC PDM is running. This can be printed out and saved.

5.3 Maintenance Engineer / Specialist

Maintenance engineer

In "Maintenance engineer" mode you can only carry out the modifications necessary for operation and maintenance in the parameter table.

Specialist

If a password has been defined in the "Settings" dialog box, the current password must be entered when selecting the option field "Specialist" in the "User" dialog box which is displayed when starting the application.

The extended modification possibilities are then available for the specialist in the parameter table.

5.4 Main Window

The "SIMATIC PDM" main window remains on the screen throughout the complete working session, and is partially or totally covered by other activated dialog windows.

The main window consists of:

- Title bar
- Menu bar
- Toolbar
- Parameter group overview (on the left in the working window)
- Parameter table (on the right in the working window)
- Status bar

5.5 Parameter Group Overview

The parameter group overview is displayed in the left part of the main window.

The objects and their parameter groups are displayed here as well as any possible existing subordinate objects. The selected group (only one group can be selected at any time) is displayed with a blue background. The parameters belonging to the selected group are now displayed in the parameter table. The subgroups with their parameters are also visible if the **Display subentries** entries is activated in the **Options** menu.

If you have changed a value in the parameter table, the color of the corresponding directory symbol changes from yellow to blue. In addition, the main directory symbol (first line of the parameter group overview) is now also displayed in blue. If the modified value is invalid, the color of the corresponding directory symbols change to red.

Note

To get faster results when refreshing the screen display, we recommend that you only select the parameter group (in the parameter group overview) that you actually intend to edit.

5.6 Parameter Table

The right-hand part of the main window is filled by the parameter table.

This parameter table lists the individual parameter groups in succession (as listed in the parameter group overview). A hierarchy as in the parameter group overview is not displayed here.

If you click a parameter group in the parameter group overview, the group is displayed in the parameter table. If the "Display subentries" line has been activated in the "Options" menu, all subgroups of the selected parameter group are also displayed. If the line is inactive, only the parameters of the selected group are displayed.

Each parameter group commences with a heading with the name of the group on a colored background. The special characters preceding the heading text indicate the level of the heading. The individual parameter lines are positioned underneath the heading.

A field on a white background can be edited, the other fields cannot.

The number of parameters which can be edited depends on the selected status (Maintenance engineer / Specialist) and possibly on parameter values.

The parameter table is divided into the following columns:

- Parameter
- Value
- Unit
- Status

If the table is longer than the screen area, a scrollbar is displayed at the right edge.

Note

To get faster results when refreshing the screen display, we recommend that you only select the parameter group (in the parameter group overview) that you actually intend to edit.

Functions of the Right-hand Mouse Button

Clicking the right-hand mouse button within the parameter table opens a pop-up menu with the following possible displays and functions:

Entry	Explanation / operating information
Minimum value:	Displays the smallest permitted value of the parameter. `)` ``)
Maximum value	Displays the largest permitted value of the parameter. `)` **)
Initial value	Displays the initial value of the parameter. `)`
Default value	Displays the default value of the parameter. `)` **)
Help	When you select this entry you will receive context-related Help on parameters.
Online	Displays an online dialog box (if selected under Options > Settings > Table). The tab card shows the current parameter value from the device. You can change the parameters and write them directly into the device. The value in the parameter table is not affected by this. It only changes after another "Upload to the programming device/PC" procedure.

*) Clicking on the value with the left mouse button transfers the value to the parameter table.

**) There can be several minimum, maximum and default values.

Note

These displays / functions must be supported by the device description.

5.7 Log

SIMATIC PDM provides an integrated log tool. You can activate it and determine which log messages are to be output. If you activate the log tool, a window with the most important messages is displayed while SIMATIC PDM is running. This can be printed out and saved. The log is used to search for errors at communication problems with the device.

The messages are weighted in accordance with their meaning and the following categories exist:

- Errors
- Warnings
- Communication log
- Details
- All messages

6 Loading of Data Between Various Devices

While on the configuration level of the SIMATIC Manager you can load the data for configured devices across a complete plant, across a unit or for individual devices into the device or into the PC/programming device without having to open SIMATIC PDM for each device.

You have the following possibilities for loading data:

- Downloading to the devices/uploading to the programming device/PC of the selected device
- Downloading to the devices/uploading to the programming device/PC of the selected device and of the devices in the first level under the selected device (only for remote I/O)
- Downloading to the devices/uploading to the programming device/PC of the selected device and of all the devices under the selected device

Loading of data across a complete plant is carried out without interruption. Any errors occurring and other messages are saved and displaced afterwards.

The **Upload to the Programming Device/PC** function is used to download all the device variables of a device object from the device into the off-line database.

The **Download to the Devices** function is used to download all the device variables of a device object from the off-line database into the device.

Proceed as follows in order to load data in the network view or the plant view:

1. Click on the desired device with the right-hand mouse button and select the context-sensitive menu command **Download to the Devices** or **Upload to the Programming Device/PC**.
2. Select the desired settings in the displayed dialog box "Download to the Devices" or "Upload to the Programming Device/PC".
3. Confirm your settings with "OK".

During the loading process, a dialog box is displayed which shows the objects already processed in a tree structure similar to that of the SIMATIC Manager. Any faults occurring at a device do not cause the complete action to be aborted, but only apply for the device just processed.

The dialog box is updated during the loading process. The status "In process" is displayed in the title bar while the process is active. The status "Result" is displayed after the process has been completed.

6.1 Processing Results

After the data have been downloaded to the configuration level of the SIMATIC Manager, you can have the processing results displayed.

In order to view the messages select the desired device and click on the “Properties...” command button or double-click on the corresponding icon. The “Properties” dialog box with the messages on the device is displayed.

Saving and displaying the messages

The messages created while the data were last being downloaded to the device or uploaded to the programming device/PC are saved with the object data of the device and are added to the “Properties” dialog box in the tab cards “Download to the Device: Status” or “Upload to the Programming Device/PC: Status”. This means that the messages can be viewed not only immediately after they have been loaded but also at a later point.

7 Importing/Exporting Configuration and Parameter Data

The configuration and parameterization data of projects with PDM objects can be exported as PDM data and be imported at another point (for example, into another project or into another PC).

Complete projects or project sections (partial trees in the tree view of the process device network view or plant view) can be exported or imported.

To open a PDM file, go to the Explorer and double-click the file desired.

Since the exported data are saved in XML format, they can, for example, also be converted easily into other formats by means of XSL files and can be displayed or modified by means of external tools. The SIMATIC PDM CD contains an XSL file by means of which the exported data can be converted to the CSV format (Comma Separated Values) so that they can be displayed in common software projects in tabular (spreadsheet) form.

Exporting data

Proceed as follows in order to export data:

1. Select a PDM object in a view of the SIMATIC Manager and press the right-hand mouse button.
2. In the pop-up menu of this object select the entry **Export...**
3. In the displayed dialog box specify the name and position at which the PDM file containing the exported data is to be saved and confirm your entries by clicking on "OK".
4. The selected object and **all** the objects lying below this object are exported. During the exporting process a dialog box is displayed which shows the objects already exported in a tree structure similar to that of the SIMATIC Manager. Any faults or errors occurring at a device cause the complete action to be aborted.
The dialog box is updated during the exporting process. The status "In process" is displayed in the title bar while the process is active. The status "Result" is displayed after the process has been completed.

Importing data

When importing data, you can choose between the following two options:

- **Comparative Import:** You can use a comparative import to organize data that already have been exported and then externally edited so that they can be efficiently re-imported at the same location. In addition, you can import data located and exported with SIMATIC PDM LifeList into existing projects.

In a comparative import, each device type is checked (based on the assigned device DDL) to determine if it is identical. If device type is not identical, a dialog box is displayed in which you can indicate whether it should still be imported or not.

Each object is then checked to determine when it was last changed. During this process, the following distinctions are made:

- In the case of an object that was changed in the project but not in the file to be imported, a dialog box is displayed in which you can indicate whether it should still be imported or not.
- In the case of an object that is identified as changed in both the file to be imported and the project, a dialog box is displayed in which you can manually select the objects that you want to import.
- If an object is shown as having only been changed in the file to be imported, then it is imported without any request for user confirmation.
- In addition, a check is made to determine whether several "identical" objects exist on the current configuration level in the file to be imported or in the project. During this process, the following distinctions are made:
 - If the file to be imported contains several identical objects, only the first of these objects is imported (You will receive a message indicating this condition.).
 - If the project contains several identical objects, a comparative import is not carried out for this objects (You will receive a message indicating this condition.).
- **Additive Import:** In this case, all objects in the file to be imported are inserted, regardless of whether identical objects already exist in the project.

Note

The determination of whether objects are considered to be 'identical' depends on the specific object type. For all currently existing SIMATIC PDM object types, objects with the same object name or the same TAG are considered identical. For submodules (e.g. remote I/O submodules), those submodules with the same slot number are considered identical.

Proceed as follows in order to import data:

1. Select a PDM object under which you want to import a partial project in a view of the SIMATIC Manager and press the right-hand mouse button. In the pop-up menu of this object select the entry **Import...**

Note

If a complete project was exported previously, you can also click on the file with the extension .pdm.

2. In the "Import" dialog box, specify whether you want to carry out an additive or comparative import, and confirm your choice with "OK".
3. In the displayed dialog box specify the name and position of the PDM file containing the imported data and confirm your entries by clicking on "OK".
4. During the importing process a dialog box is displayed which shows the objects already imported in a tree structure similar to that of the SIMATIC Manager. Any faults or errors occurring at a device cause the complete action to be aborted.
The dialog box is updated during the importing process. The status "Processing" is displayed in the title bar while the process is active. The status "Result" is displayed after the process has been completed.



Caution

- During the importing process, ensure that the type of the object on which you have carried out the export can be configured below the selected PDM object. It is thus, for example, not possible to export a HART device and then import it below a PROFIBUS network. If you import the data at the incorrect position, a message is displayed stating that the object of the type x (= type of the exported object) cannot be configured under an object of the type y (= type of the selected object).
 - Objects which are linked to HW-Config objects lose this link during the export.
 - Before exporting, ensure that there are no identical objects in a subtree (such as Name, Slot Number). Otherwise, conflicts may occur during a subsequent comparative import.
 - Objects that were originally only present once will possibly be exported several times and thus also imported several times. Thus, a HART device that has been configured several times (such as in a HART modem network, in an ET200M and in a multiplexer network) will appear several times when exporting. When importing, this object will also be created several times, even if it is actually only a single device. This means that such objects can exist several times in the plant view.
 - If the object type for the root object in the import file matches the object selected in the project, the root object will be imported **comparatively** and not inserted under the selected object, since this would then mean that networks or devices could not be imported.
-

"Import - In process..." Dialog Box











"Export - In process..." Dialog Box

7.1 "Import - In Process" Dialog Box

This dialog box is displayed during the importing process. It shows the objects already processed in a tree structure similar to that of the SIMATIC Manager. Any faults or errors occurring at a device cause the complete action to be aborted.

The dialog box is updated during the importing process. The status "In process" is displayed in the title bar while the process is active. The status "Result" is displayed after the process has been completed.

The device icons used have the following meanings:

	The import was carried out error-free.
	The import was carried out error-free and a new object was added.
	The address of the object changed during the comparative import.
	The import was not carried out at this device because the object has not been changed.
	Messages and warnings occurred during the import.
	The import was aborted due to an error.
	The object is currently being edited elsewhere.
	The import was not carried out at this device.
	The device does not support this function.
	The import is being carried out at this device.

"Properties..." command button







Click on this command button in order to have the properties for the selected device displayed.

7.2 "Export - In Process" Dialog Box

This dialog box is displayed during the exporting process. It shows the objects already processed in a tree structure similar to that of the SIMATIC Manager. Any faults or errors occurring at a device cause the complete action to be aborted.

The dialog box is updated during the exporting process. The status "In process" is displayed in the title bar while the process is active. The status "Result" is displayed after the process has been completed.

The device icons used have the following meanings:

	The export was carried out error-free.
	Messages and warnings occurred during the export.
	The export was aborted due to an error.
	The object is currently being edited elsewhere.
	The export was not carried out at this device.
	The device does not support this function.
	The export is being carried out at this device.

"Properties..." command button

Click on this command button in order to have the properties for the selected device displayed.

8 Distributed Editing of Projects

With SIMATIC PDM, you have the option of editing projects in a distributed manner. To do this, you can read the device data out from a central project and use them to set up devices on location. After this, you can import the device data changed on location back into the central project. In order to be able to do this, SIMATIC PDM must also be installed on the portable computer being used.

To edit a project in a distributed manner, proceed as follows:

1. Export the desired device data from the central project.
2. Transfer the .pdm file to a portable computer.
3. Double-click the .pdm file on location. SIMATIC PDM opens and you can now transfer the device data to the intended devices.
4. If necessary, change the data at the device. Then load the changed data back to your portable computer and save the .pdm file.
5. Transfer the .pdm file to computer with the central project
6. Import the .pdm file (comparative import) into the central project.

Note

If any changes were made to the central project in the meantime, a message to this effect will be displayed. You can then decide which information should be transferred.

For detailed information on exporting and importing device data, see the section Importing/Exporting Configuration and Parameter Data.

9 Communication

9.1 Secure Communication

In SIMATIC PDM, whenever you establish an online connection to a device, relevant points such as the following are checked while the connection is being made:

- Does the device type match?
- Is it the same type of device?
- Were changes made to the device that are not yet saved in the project?

If a connection is interrupted, SIMATIC PDM automatically attempts to establish a new connection. Any errors that occur are displayed and logged.

If a device did not accept the data in an identical manner, the values that were written to the device and the actual values read back from the device are displayed. You can then decide whether or not to use the changed values in your project.

After the identification test, the device status is determined and the device is displayed with the appropriate icon.

9.2 Communication Problems

If communication problems occur, check the following points:

Problems while a connection is being established

- **Configuration**
 - Is the programming device/PC interface configured correctly? You can access the configuration of the programming device/PC interface via the SIMATIC Manager via the **Options > Set Programming Device/PC Interface** menu command or via the Control Panel of Windows.
 - If configuration is not carried out via HW-Config: Is an interface - the correct one - assigned to the PC and is this interface assigned to a network - the correct one?
 - In case of routing: Is a programming device/PC included in the project in the component view? Is an interface - the correct one - assigned to the programming device/PC?
 - Are the addresses (address, slot, channel) assigned correctly and uniquely in the project?
 - Has the correct communication path been selected? Depending on the configuration, devices can be accessed via various communication paths - for example, HART devices can be reached via ET 200 M, a HART module and a HART interface network.
 - Has an inappropriate device been assigned from the catalog? In the dialog box "Properties" select a new device from the list "Supported Devices and Profiles", information on which you can find in the README file. If you still have problems contact your device dealer.
- **Hardware structure**
 - Is the plant complete and has it been cabled correctly? Are all the connectors plugged in correctly? Are the modules plugged correctly?
 - Are all the modules and devices of the plant supplied correctly?
 - Are there low-or high-frequency disturbances in the plant? Is the plant subject to the influence of electromagnetic fields?
 - Is there short circuit at the bus or a wire break in a wire leading to the device?
- **Addressing the devices**
 - Are the addresses (address, slot, channel) set correctly at the devices in the plant?
 - Do the addresses set at the devices agree with the configured addresses? The settings at the devices are carried out via hardware switches, configuration or a combination of both. In the case of PROFIBUS DP/PA devices the device address can be set from SIMATIC PDM - See also assigning addresses.

- **Software in the CPUs, CPs**
 - The software downloaded to the CPUs or CPs has to agree with the configuration. In HW-Config the configuration is downloaded to the CPU or CP of the station by means of the **PLC > Download to Module > Select Target Module** menu command.
- **Maximum number of connections**
 - Devices or communication components can only manage a restricted number of open connections. It is therefore possible that connections cannot be established. To open new connections to devices, close S7 applications. For information on the maximum number of connections permitted, please refer to the respective device manuals.

Communication Errors

Communication errors may occur when using standard device descriptions, for example HART Universal Standard or a PROFIBUS profile description.

- The reason for this may be an unsuitable device assignment. If this is the case, assign a suitable device in the "Properties" dialog in the "Device" Tab. For further information, for example on firmware versions, see the "SIMATIC PDM - Integrated Devices" reference file, which you can open by using the Windows Start menu (Start > SIMATIC > Documentation > English).
- Another reason may be that the device does not fulfill or fully implement the standard. Please contact the device manufacturer in this case.

Disconnection of a connection

- **Address changes**
 - Was the address of a device changed at the device without recording this change in the configuration?
- **Reset functions**
 - Was a reset function triggered in the device? A reset can be triggered manually or by the firmware of the device (for example, in case of hardware errors, incorrect program execution). The reset can block the device in a defined "secure" operating state or trigger a restart of the program with basic settings. These basic settings can differ from the desired settings, for example incorrect address, transfer speed.
- **Disturbances**
 - Do low-or high-frequency disturbances occur in the plant or is the plant subject to the influence of electromagnetic fields? Has the power supply of the plant, of parts of the plant or of devices been disconnected? Have connectors or plugs been withdrawn or plugged in elsewhere?

Notes

If other communication problems occur, please contact the device manufacturer.

9.3 Communication via SIMATIC S7 Stations (Routing)

9.3.1 Routing

Overview

In most automation plants the programming device can only be operated via the bus cable (subnet) connected to the automation system. In larger networked plant this therefore means that the programming device has to be connected to various bus cables (subnets) before an automation system which lies far away can be reached online.

The routing function allows you to reach automation systems online across subnet limits with the programming device/PC, in order, for example, to download user programs or a hardware configuration or to carry out debugging functions.

Routing is also possible via TELEPERM XP. You can route via SIMATIC S7 stations or via TELEPERM XP stations.

The "Programming Device Routing" functionality allows you reach automation devices across different subnets from a fixed position in the plant without having to plug over the bus connectors. To this purpose special "routing tables" for the network transitions are generated automatically during the network configuration with STEP 7. These routing tables are special system data and have to be downloaded to the network transitions, meaning the S7 CPUs or CPs. The path to the selected automation device can then be found via the network transitions when the programming device goes online.

The transition from one subnet to one or more other subnets lies in a SIMATIC station that has interfaces to the respective subnets.

Prerequisites

- STEP 7 above Version 5 and SIMATIC PDM (meaning that you work with SIMATIC PDM integrated).
- The modules with communication functionality (CPUs or CPs) which establish the network transitions between the subnets have to be capable of routing.
- All the automation devices or communications partners which can be reached in a plant network have to be configured and downloaded within an S7 project.
- The desired S7 station is networked and can really be reached via the network transitions.
- The modules have to be downloaded together with the configuration information, which contains the current "knowledge" on the complete network configuration of the projects.
Reason: All the modules participating in the network transition must contain the information on which subnets can be reached by which routes (routing tables).

- The programming device/PC to which you want to establish an online connection has to be configured in the network configuration and assigned to your generation system.

9.3.2 Creating a Routing Configuration

Proceed as follows in order to create a network which enables routing:

1. Create a new project in the SIMATIC Manager by using the **File > New** menu command and enter a name for the project in the displayed dialog box.
2. If necessary, change to the component view (**View > Component view** menu command).
3. Select the project, press the right-hand mouse button and select the entry **Insert New Object > SIMATIC Station**. Objects are now created in the right-hand part of the window.
4. Double-click on "Hardware". The module catalog is opened. Select a rack, a power supply unit and CPU which enables routing from the module catalog and drag-and drop the selected devices into your configuration. Configure the CPU.
5. Insert an Ethernet or a PROFIBUS interface.
 - **Ethernet interface:** Select an Ethernet CP (CP443-1, ISO or TCP) and drag-and-drop it to the desired slot. Open the "Properties" dialog box by double-clicking on the CP. Enter all the required settings (MAC address, IP address, etc.) in the "Parameters" tab card.
Note: If you do not know the MAC or IP address of the interface, you can have the network configuration of your plant checked and displayed by "pinging" the Internet address.
 - **PROFIBUS interface:** Select a PROFIBUS CP (CP443-5, extended) and drag-and-drop it to the desired slot. Open the "Properties" dialog box by double-clicking on the CP. Enter all the required settings (DP address) in the "Parameters" tab card. Now click on the "New" command button and enter the transfer rate in the "Network Settings" tab card in the displayed dialog box. Click on the "DP Master" option in the "Operating mode" tab card and confirm your entries with "OK".
6. Save the project to your CPU by using the **PLC > Download to Module** menu command.
7. Change to the SIMATIC Manager and from there, if necessary, to the component view.
8. Select the project, press the right-hand mouse button and select the entry **Add New Object > Programming Device/PC**. The programming device or the PC is now inserted.

9. Double-click on the icon and enter the interfaces which are installed in your programming device/PC into the "Interfaces" tab card in the displayed dialog box. To do so, click on the "New" command button and select the desired interfaces. You still have to set the addresses and select the desired network for the interfaces.
 - Ethernet interface: Enter the MAC address of the interface installed in your programming device/PC.
 - IP interface: Enter the MAC address, the IP address and the subnet mask of the interface installed in your programming device/PC.

Note: If you do not know the addresses of your interfaces, you can find these out under Windows NT by using the DOS command box with the command "ipconfig /all". Under Windows 98 the command is "winipcfg". If you enter this command and press the Return key, all the device data are displayed.
10. Connect the interface to the Ethernet line, select the subnet and click on "OK" to confirm your entries. Select the interface and the network board in the "Assignment" tab card and click on the "Assign" command button.

Your programming device/PC is now configured so that you can establish connections to other subnets and read data from devices in SIMATIC PDM without having to replug the bus connector.

Note

If the communication path being used in a redundant STEP 7 station fails, this failure will be reported. The next time you call a function that requires communication to the device, an alternative connection path will be selected if the default one is not available.

10 SIMATIC PDM LifeList

10.1 Introduction

With this program you can scan DP and PA chains and determine what HART devices are connected to a HART modem (multi-drop mode). You can specify whether the scan process is run once or in cycles and whether subnets should also be scanned. You can change the addresses and TAGs for devices directly in the SIMATIC PDM LifeList, and you can apply these changes to existing projects.

SIMATIC PDM LifeList supports XML export of LifeList data. The XML file imported into existing projects are used to create or compare device and network data.

You can save the data generated in the SIMATIC PDM LifeList, and if necessary, print them out.

Starting SIMATIC PDM LifeList

Regardless of the project, you can open SIMATIC PDM LifeList by means of the Windows Start button (**Start > Simatic > STEP 7 > SIMATIC PDM LifeList**) or in the SIMATIC Manager by selecting the desired object, right-clicking, and then selecting the context menu **SIMATIC PDM > Start LifeList**.

10.2 Starting SIMATIC PDM

To start SIMATIC PDM from LifeList, you have the following options:

- Double-click an object
- Select the object desired and then select the menu command **Device > Open object...**

In either case, a dialog box is displayed in which you can make the settings required to import data. The dialog box is updated during the import. As long as the import continues, the title bar will display the status "In process". After the import is complete, it will display the status "Result". After closing the dialog box, select your access authorization ("Maintenance engineer" or "Specialist") in the dialog box that then appears. After this, the SIMATIC PDM use interface will open.

10.3 User Interface

The "SIMATIC PDM LifeList" main window contains the following elements:

- **Title bar**
Shows the file name and the project name
- **Menu bar**
Contains the menu commands
- **Toolbar**
Contains the buttons for quick access to commonly used menu commands.
- **Hierarchical node list**
Contains the current scan result (appears as soon as scanning starts)
- **Status bar** (with progress indicator)
Contains information on the scanning process currently underway

As soon as scanning starts, the node list is constructed as a tree hierarchy.

The node that has been newly determined is highlighted during the scanning process.

The first column contains the nodes arranged according to their network hierarchy. The other columns specific information about the nodes. This information will depend on the type of communication concerned: For PROFIBUS PA devices, the last column contains the block structure. For HART devices, the last column contains the long address.

Notes

- In order to determine the complete device status you have to activate the "With diagnostics" option in the "Options" dialog box (menu command **Scan > Options**).
 - For devices that are not integrated in SIMATIC PDM, "Device type: ID = ?????" is displayed. The device cannot be identified and no diagnostic information can be determined. All "Device" and context menu functions are disabled. To integrate the device in SIMATIC PDM, please contact the manufacturer of this device.
 - When determining the device status of a device, it is possible that the diagnostic information is not determined completely. In this case, please contact the manufacturer of this device to integrate the device completely in SIMATIC PDM.
-

After you select node, you can right-click to obtain a context menu pertaining to it.

10.4 "SIMATIC PDM LifeList" Dialog Box

In this dialog box you make the basic settings for SIMATIC PDM LifeList. You can change this settings later by selection the menu command **Scan > Options**.

Communication

- **PROFIBUS / HART Modem**
This setting determines the type of communication for the scan procedure.
- **Address** (setting range: 0 ... 126, for PROFIBUS only)
This setting determines the address range at the highest scan level (PROFIBUS DP). Here you can make restrictions, such as to limit the address range to scanning a DP/PA link. In this way, you can speed up the scanning process.
- **COM port** (COM1 ... COM8, for HART modem only)
This setting determines the COM port to which the HART modem is connected.

Scanning

- **Scan immediately after Start**
If you select this option, the scanning process will be automatically started after having started SIMATIC PDM LifeList.
- **Scan cyclically**
If you select this option, the scanning process will be automatically continued after the first run. Each new run will update the results of the previous one; that is, newly detected nodes will be inserted and no longer existing ones will be removed from the scanning result.
If this option is not selected, the scanning process will be automatically ended after the first run is completed.
- **Wit Diagnostics**
If you select this option, additional diagnostic information is added to the scan result.
- **Scan subnets**
If you select this option, subordinate networks will be included in the scanning process.
(such as PA devices behind the DP/PA link).
If this option is not selected, only the nodes at the primary level will be determined.

Display dialog during startup

This option is selected by default. The start dialog appears each time the program is started and contains no context information (project context or call parameters). If you clear this option, the settings from the last session will be automatically applied again.

10.5 "Options" Dialog Box

In this dialog box you make the basic settings for SIMATIC PDM LifeList.

Communication

- **PROFIBUS / HART Modem**
This setting determines the type of communication for the scan procedure.
- **Address** (setting range: 0 ... 126, for PROFIBUS only)
This setting determines the address range at the highest scan level (PROFIBUS DP). Here you can make restrictions, such as to limit the address range to scanning a DP/PA link. In this way, you can speed up the scanning process.
- **COM port** (COM1 ... COM8, for HART modem only)
This setting determines the COM port to which the HART modem is connected.

Scanning

- **Scan cyclically**
If you select this option, the scanning process will be automatically continued after the first run. Each new run will update the results of the previous one; that is, newly detected nodes will be inserted and no longer existing ones will be removed from the scanning result.
If this option is not selected, the scanning process will be automatically ended after the first run is completed.
- **Wit Diagnostics**
If you select this option, additional diagnostic information is added to the scan result.
- **Scan subnets**
If you select this option, subordinate networks will be included in the scanning process.
(such as PA devices behind the DP/PA link).
If this option is not selected, only the nodes at the primary level will be determined.

Display dialog during startup

This option is selected by default. The start dialog appears each time the program is started and contains no context information (project context or call parameters). If you clear this option, the settings from the last session will be automatically applied again.

11 Device Install

11.1 Integrating Devices in SIMATIC PDM with "Device Install"

This utility is installed together with SIMATIC PDM. It can only be started from the Explorer. You can, however, also create a shortcut to the EXE file on the Desktop, for example.

Call: `DeviceInstall.exe` in the `..\Pdm\Sim_pdm\DeviceInstall` folder

DeviceInstall is a tool for installing individual devices in SIMATIC PDM if they are not yet included in the latest version of SIMATIC PDM.

In the initial dialog, click on the "Next" button. In the dialog box that is displayed, select the component(s) that you want to integrate. Then click the "Finish" button. After the installation is complete, you can click on the "Details" to view the installed files, their storage path and any related comments.

Caution

Any devices that you integrated in a previous version of SIMATIC PDM (prior to SIMATIC PDM V5.2), will not be displayed after an upgrade or a reinstallation of SIMATIC PDM V5.2 (or higher), and you will receive an error message. In this case, you will have to reintegrate these devices using the "Device Install" function.

11.2 Integrating Devices in SIMATIC PDM with HW Config

If a DP slave is not displayed in the "Hardware Catalog" window, you will have to install the corresponding GSD file supplied by the manufacturer.

To do this, select the **Options > Install New GSD** menu command. In the dialog box that is displayed, select the drive/folder containing the desired GSD file.

Result: The DP slave is entered in the "Hardware Catalog" window (only in the "Standard" catalog profile!) under "PROFIBUS-DP \ Other field devices" and is now available for configuration.

After you have select the desired device and placed it, select it and then right-click to display the context-sensitive menu command **Object Properties**. In the dialog box now displayed, select the check box "Configuration by Means of PDM" so that you can edit the device in SIMATIC PDM.

Index

"

"Export - In Process" Dialog Box	7-5
"Import - In Process" Dialog Box	7-4
"Options" Dialog Box	10-4
"SIMATIC PDM LifeList" Dialog Box.....	10-3

A

Address modifications	9-2
Addressing the devices	9-2
Authorization	1-5

B

Block Configuration	3-15
---------------------------	------

C

Communication Problems	9-2, 9-3
Configuration	2-1, 2-2, 2-3, 3-1, 3-6, 3-9, 3-12, 3-13, 3-14, 3-15, 3-18, 3-26, 3-28, 4-1, 4-2, 9-2, 9-3
Configuring Networks and Devices	3-1
Connection Abortion.....	9-2
Coupling a Device in HW-Config.....	4-2
Coupling a Device in the Process Device Network View	3-10
Coupling a Device in the Process Device Plant View.....	3-13
Coupling a HART Device to a HART Modem in SIMATIC PDM.....	3-20
Coupling a HART Multiplexer Network	3-21
Coupling a MODBUS Network	3-32
Coupling a PROFIBUS Device in SIMATIC PDM.....	3-16
Coupling a SIPART DR Controller	3-28
Coupling a SIPART DR Device to an RS 232C/RS 485 in SIMATIC PDM.....	3-27
Coupling a SIREC Network	3-30
Coupling a SIREC Process Recorder.....	3-31
Coupling HART Devices via HCF-DDs.....	3-26
CPU CP Software	9-2
Creating a STEP 7 Project	4-1
Creating a Project in the Process Device Network View	3-9
Creating a Project in the Process Device Plant View.....	3-13
Creating a Routing Configuration	9-5

D

Device Icons	3-8
Diagnostics	3-15
Distributed Editing of Projects.....	8-1
Distributed periphery.....	3-18

E

Error handling	3-15
Exchanging devices.....	3-14
Exporting Configuration and Parameter Data	7-1
Exporting Data	7-1

F

Faults.....	9-2
Field of application.....	1-1
First Steps with SIMATIC PDM.....	5-3

H

Hardware Structure.....	9-2
HART Devices	3-15
HCF Library	3-26
How SIMATIC PDM Works.....	5-1

I

Icons	3-8
Icons for Devices	3-8
Importing Data	7-2
Information on Configuration and Parameterization.....	3-15
Inserting Several Devices at the Same Time	3-13
Installation	1-6
Installing SIMATIC PDM	1-6
Integrating Devices in SIMATIC PDM with "Device Install"	11-1
Integrating Devices in SIMATIC PDM with HW Config.....	11-2
Introduction	1-1, 10-1

L	
Language Setting	3-5
Loading of Data between Various Devices	6-1
Log	5-9
M	
Main Window	5-6, 5-7
Maintenance Engineer	5-5
Maintenance Engineer / Specialist	5-5
N	
Network view	3-8
Network View	3-8
O	
Opening an Existing STEP 7 Project	4-2
P	
Parameter	5-7, 5-8
Parameter Group Overview	5-6
Parameter Groups	5-6
Parameter Table	5-7, 5-8
Parametrization	3-15
PC/Programming Device Interface	3-15
Plant View	3-8
Problems at Connection Establishing	9-2
Process Devices-Network View	3-6
Process Devices-Plant View	3-6
Processing Results	6-2
PROFIBUS	3-15, 3-17
Profile Devices	3-17
R	
Remote I/O Systems	3-18
Removing SIMATIC PDM	1-6
Reset Functions	9-3
Routing	9-4
S	
Sample projects	1-2
Secure Communication	9-1
SIMATIC Manager	3-5
SIMATIC Manager Views	3-6
SIMATIC PDM	3-9, 3-15
SIMATIC PDM Integrated	4-1
Specialist	5-5
Starting HW Config	4-1
Starting HW-Config	4-2
Starting SIMATIC PDM	10-1
Starting SIMATIC PDM in HW-Config	2-2
Starting SIMATIC PDM in LifeList	2-3
Starting SIMATIC PDM in the Process Device Network View	2-1
Starting SIMATIC PDM in the Process Device Plant View	2-2
U	
User Interface	10-2
Utilities	11-1
W	
What is New in SIMATIC PDM V5.2?	1-3