

SIPART DR24

Multi-function Unit

7



7/2	Description
7/2	Application
7/3	Design
7/3	Mode of operation
7/7	Basic functions
7/8	Complex functions
7/16	Serial interface

7/17	Technical data
-------------	-----------------------

7/19	Ordering data
-------------	----------------------

7/20	SIPART DR24 input/output modules
-------------	---

7/20	Overview: applications
------	------------------------



SIPART DR24 Multi-function Unit

6DR2410-

Description

Application

The SIPART DR24 multi-function unit is used in process engineering applications for calculation, closed-loop and open-loop control. The unit can be freely configured to suit the application. During configuring, functions stored in memory (Fig. 7/1) are, through simple allocation, selected and connected to one another, to the inputs and outputs, and to the indicators and pushbuttons of the control and display unit.

No programming knowledge is necessary.

The multi-function unit can be connected to higher level automation systems, control systems or process computers using analog, parallel interfaces, as well as via an addressable bus-based serial interface.

The multi-function unit can be installed in panels, desks or cabinets.

Application examples

- Calculator for mathematical equations, timing sequences, logic operations and arithmetic operations executed in parallel
- Programmer (clock), also in conjunction with calculations, open-loop and closed-loop controls
- Closed-loop controller with continuous manipulated variable and/or three-position step controller; inputs and outputs of controller blocks freely connectable, e. g. to calculation and

open-loop control functions; as a single-loop controller or for parallel operation for up to 4 independent control loops, for selection controls, cascade control, SPC or DDC mode

- Program controller; up to 8 programs
- Boiler control with mathematical evaluation of process variables (min./max. selection, correction computer etc.)
- Closed-loop burner control with open-loop control functions
- Thermodynamic closed-loop process control and calculations (enthalpy)
- Closed-loop furnace and zone control with programmed setpoint control and linearization
- Open-loop and closed-loop test bed control
- Closed-loop control of transport systems (e. g. conveyor belts) with dead time element
- Surge limit control
- Transmitter for analog and digital process variables to and from the serial interface
- Process monitoring (limit violations, failure alarms etc.)
- Dependent and mutually interlocking/overriding setpoint control
- Multiplexer for process variables and/or setpoints
- Weighted average calculation using sampled values

<u>Mathematical functions</u>		<u>Logic functions</u>		
AbS	Absolute value	And	AND	
Add	Add	dFF	d flip-flop	
AMPL	Differential amplifier	Eor	Exclusive OR	
div	Divide	nAnd	NAND, also inverted	
FUL	Function generator (3)	nor	NOR, also inverted	
FUP	Function generator (2)	or	OR	
LG	Log base 10	tFF	t flip-flop	
LinE	Straight line equation	tiME	Timer	
Ln	Log base e	CoUn	Counter	
MuLt	Multiply, negation	PUM	Pulse width modulation (4)	
Pot	Exponentiation	<u>Switches</u>		
CpT	P/T correction computer (2)	MUP	Multiplexer (2)	
root	Square root extraction	ASo	Analog variable selector	
SUb	Subtract, negation	bSo	Digital variable selector	
SPr	Splitrange (8)	Cnt	Demultiplexer	
<u>Time functions</u>		<u>Memory functions</u>		
AFi	Adaptive filter (2)	AMEM	Analog value memory	
diF	Differentiate (high-pass)	dFF	d flip-flop	
FiLt	Filter (low-pass)	Ain	Integrator with analog input, tracked (see above)	
Ain	Integrator, analog input (4)	bin	Integrator with digital input, tracked (see above)	
bin	Integrator, digital input (6)	MAME	Maximum memory	
tiME	Timer	MiME	Minimum memory	
dti	Dead time element (2)	tFF	T flip-flop	
CLoc	Programmer (1)	<u>Programmer</u>		
<u>Comparison functions</u>		CLoc	Clock (see above)	
dEbA	Response threshold	Functions marked (x) are complex functions that may be used x times (x = 1, 2 or 3). All other functions are basic functions that can be connected in any sequence and as often (max. = 109) as required.		
LiMi	Limiter	The abbreviated function names are displayed in the seven-segment display during parameterization and configuring.		
MASE	Max. selection			
MiSE	Min. selection			
AMPL	Differential amplifier			
CoMP	Comparator with hysteresis			
<u>Control functions</u>				
Ccn	} PID controller with continuous output			
CSE		} S controller with internal or external feedback (4)		
CSi				

Fig. 7/1 Basic and complex functions of the multi-function unit

Description



Fig. 7/2 SIPART DR24 multi-function unit

Design

The SIPART DR24 multi-function unit is of modular design and consequently easy to service and simple to reconfigure or retrofit. It consists of a standard device, to which additional input/output modules can be added in order to extend its range of application. These modules are inserted in slots in the rear of the instrument (Fig. 7/3).

The standard device comprises:

- the front module with controls and displays
- a main circuit board with CPU and terminal strips
- plastic moulded housing with an interface board and power pack.

Electrical connections between the various modules are made via the interface board fixed to the housing. The main circuit board is inserted in the rear of the unit in slot 1 and locked in place. The main board has 10-pin and 14-pin terminal blocks to which all inputs and outputs of the standard device are connected. If the number of signals in the standard device is insufficient for a particular application, a further five slots are available for additional option modules.

Electrical power for transmitters is provided by a short-circuit proof $L+$ -output (DC 24 V, 100 mA).

The power supply unit, an electrically isolated, stabilised switched-mode power pack, is situated in a completely enclosed metal housing that is screwed to the plastic body of the instrument.

Versions available:

- 6DR2410-4 for AC/DC 24 V power supply
- 6DR2410-5 for AC 230 V power supply, switchable to AC 115 V.

Short dips in the power supply are bridged without affecting the instrument's functionality. All voltages generated by the power pack are stabilised and short-circuit proof (thermal fuse and current monitoring).

The input of the power pack is protected against overvoltages. A filter ensures that mains glitches cannot reach the instrument

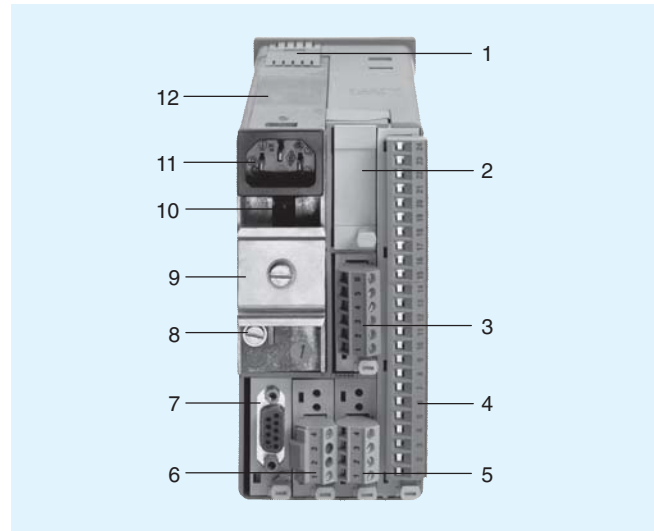

1 PE conductor - contact spring
2 Slot 6
3 Slot 5
4 Slot 1 (main circuit board)
5 Slot 2
6 Slot 3
7 Slot 4 (SES: RS 232/RS 485, PROFIBUS-DP)
8 Earthing screw
9 Top-hat rail (included in delivery of relay modules)
10 Mains voltage selector
11 Mains plug
12 Power supply unit

Fig. 7/3 SIPART DR24 multi-function unit, rear view

and that switching surges from the power pack are prevented from getting into the mains supply.

The output from the power pack is sufficient to provide a 24 V supply to a number of loads (active digital outputs, output modules) connected to earth (see Technical data).

Mode of operation

The SIPART DR24 multi-function unit is designed around a modern, highly-integrated CMOS microprocessor.

The task-specific program created by the user is stored in a non-volatile memory and is therefore protected against power failure.

Analog input area

The standard device has 3 electronically isolated analog inputs that can accept either standardized voltage (0/0.2 to 1 V or 0/2 to 10 V) or current (0/4 to 20 mA) signals.

In addition to these inputs, a module with 3 further inputs of identical types can be inserted into slots 5 and 6. These inputs can also be switched between 0 to 10 V and 0/4 to 20 mA. To handle complex control applications, or to connect other input signals, two additional input modules can be inserted in slots 2 and 3. Apart from processing standardized voltage and current signals, these input modules can also be used to connect Pt 100 resistance thermometers, thermocouples and resistance based sensors.

A total of 11 analog inputs are therefore available.

SIPART DR24 Multi-function Unit

6DR2410-

Description

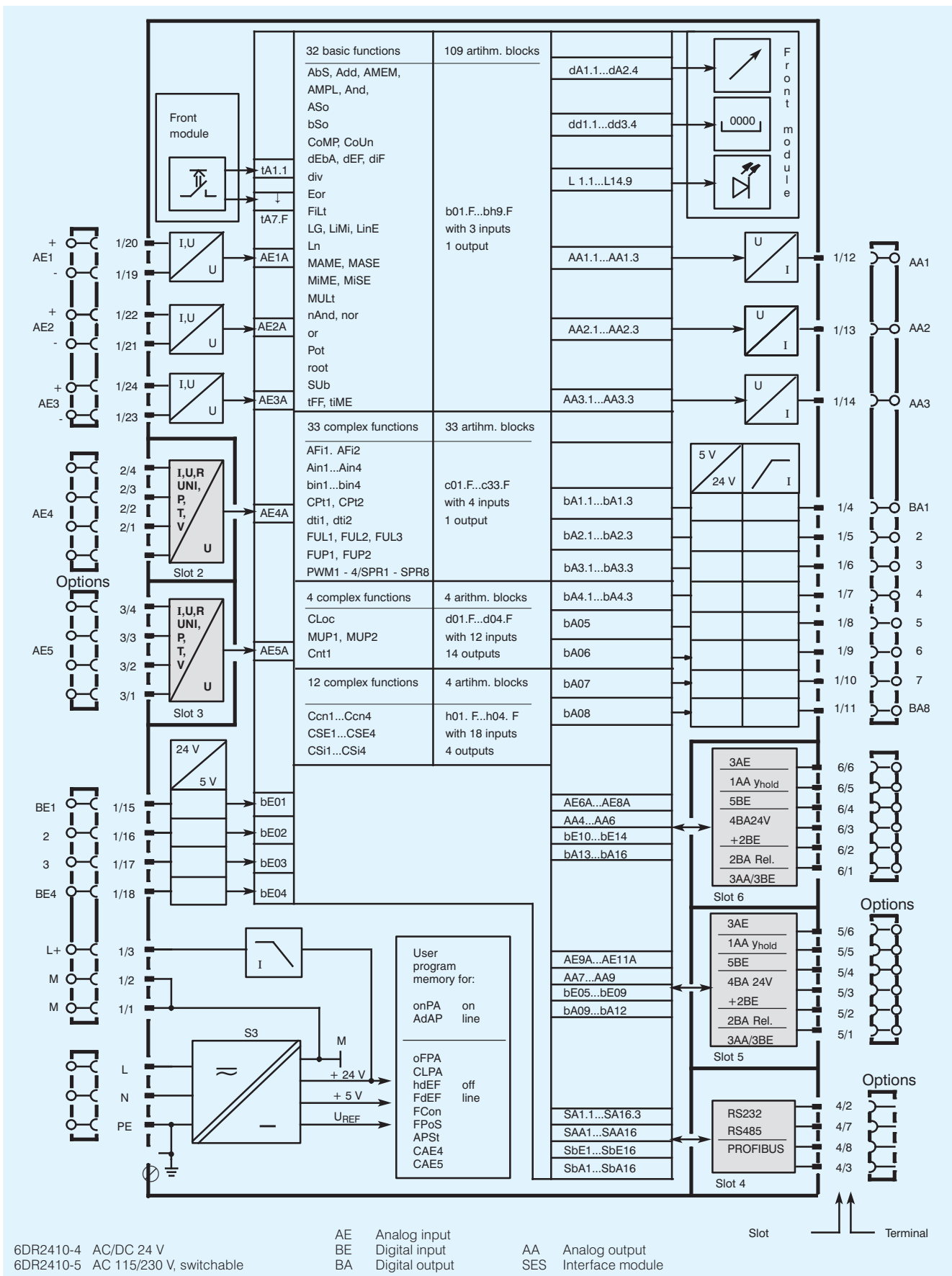

Fig. 7/4 SIPART DR24 multi-function unit, function diagram

Description

Analog output area

The standard device has 3 analog outputs. In addition to these outputs, a module with 3 analog outputs and 3 digital inputs can be inserted into each of the slots 5 and 6. The total of 9 analog outputs generate a 0 to 20 mA or 4 to 20 mA signal.

Slots 5 and 6 can be optionally fitted with an analog output module (y-hold). This module consists of a microprocessor which outputs the manipulated variable it receives from the CPU on the main circuit board. It also contains an alarm output $\bar{S}t$. In normal mode the module is powered by the controller's power pack. It can, however, also be powered via an external DC 20 to 30 V supply, in which case the internal and external supply are ORed.

This analog output module holds the most recent value of the output variable should communications between the controller's CPU and the y-hold processor fail.

Digital I/O area

The standard device has 4 digital inputs (BE1 to BE4) and 8 digital outputs (BA1 to BA8). If more are required, the number of digital inputs and outputs can be increased by using additional option modules. Slots 5 and 6 at the rear of the controller are used for this purpose. Both these slots can be used to accommodate either a module with 5 digital inputs, or one with four DC 24 V digital outputs, or a module with two relay outputs (\leq AC/DC 35 V, \leq 5 A).

The digital outputs are active and generate a DC 24 V signal.

Floating outputs are available, if the relay module with two digital outputs is used. An interface relay module can also be snapped onto a DIN rail on the rear of the controller. This additional module has either two or four relays, which are energized directly by the digital outputs. Each relay has a single CO contact.

Function area

The function area is located between the input and output areas. It contains

32 basic functions, that can be used as required up to 109 times, and

15 reusable complex functions.

The function area also contains variable parameters and a number of constants and alarms that may also be connected as necessary.

In the configuring mode, the required functions can be selected or defined (configuring mode FdEF), connected (configuring mode FCon) and positioned in the processing sequence (configuring mode FPoS).

The software connections are freely configurable. Any data source can be connected to any number of data sinks. Configuring is minimised by eliminating the data sources and sinks of undefined function blocks and by removing any illogical source/sink (e. g. analog to digital) connections.

Certain parameters can be modified during operation (on-line parameters). The remaining dedicated parameters (e. g. programmer parameters) are set off-line in configuring mode.

Example: Add basic function



$A = E1 + E2 + E3$
ncon Inputs not connected

Fig. 7/5 Basic function block, adder; the preallocated inputs (e. g. $E3 = 0.000$) can be easily overwritten if required

Arithmetic

Analog variables are processed using floating-point arithmetic within a decimal range of -10^{19} to $+10^{19}$.

The input and output variables of the multi-function unit are input or output in the signal range 0/4 to 20 mA or 0 to 10 V, corresponding to 0 to 100 %. These ranges represent the arithmetic values 0 to 1. Arithmetical operations are performed using these numeric values.

- Connectable parameters

The linear parameters PL1 to PL40 can be adjusted with a resolution of 4 digits. The parameters Pd1 to Pd40 - which should preferably be used as time constants - can be adjusted over a very large logarithmic range. PL and Pd parameters can be modified on-line in process operation.

- Back-up battery RAM

Actual values of counters, timer and memory functions can all be stored in the event of a power supply failure.

Function area "Basic and complex functions"

Configuring mode FdEF is used to define any number of function blocks in any sequence. The data sinks (inputs) can be connected (FCon) to any data source (output), e. g. to outputs from other blocks, to parameters or arithmetic variables. The basic functions and their abbreviated names are shown in Fig. 7/1. The basic function blocks and their characteristic features are listed on page 7/7.

The complex function blocks and their characteristic features are listed on pages 7/8 to 7/16.

SIPART DR24 Multi-function Unit

6DR2410-

Mode of operation

- Communication with higher-level systems

The SIPART DR24 controller can transmit and receive status flags, process variables, parameters and configuring switch settings via an interface module (option).

The following interface modules are available:

PROFIBUS DP module

- Transmission rate up to 1.5 Mbits/s
- Address range up to 125
(number of possible stations on the PROFIBUS is determined by the master interface module, the data range of the interface module, and the number of parametrized process data)

SES module RS 232/RS 485

- Transmission rate 9.6 kbits/s
- RS 232 as point-to-point connection
- RS 485 bus up to 32 stations

Monitoring function

The multi-function unit contains monitoring functions. Alarms are available as data sources and can be used to activate digital outputs, initiate function sequences or, for example, set analog outputs to their safety values.

- Self-diagnosis

Comprehensive self-diagnostics circuits cyclically control the internal data transfer, or also following a power-on reset or watchdog reset.

An error message is displayed automatically on the front module when an error is detected. This message provides enough information to identify the cause of the error and shows how it can be rectified.

If the analog output module is being used, the \overline{St} digital output on this module interrupts the High signal present during normal operation.

- Restart conditions

Depending on the actual loading on the instrument, short dips in the power supply are bridged by the storage capability of the power pack. During a longer power cut, the parameters and configurations being used are saved in a non-volatile, plug-in user program memory. The most recent mode of operation, setpoint value and manipulated variable are also loaded into fail-safe memory.

If the SIPART DR24 is equipped with an analog output module and is being supplied from a separate, fail-safe source, the most recent output value is maintained.

- Blocking of operator input as well as parameterization and configuring modes

Switching over to parameterization and configuring mode can be blocked using digital signals.

The digital input BLS blocks the switchover to configuring mode. However, on-line control parameters can still be set and adaptation, as well as normal process operation, performed.

The digital input BLPS, on the other hand, prevents the instrument from being switched out of process operation mode.

The binary function bLB blocks operation of the device.

Indicators (Fig. 7/2)

The SIPART DR24 multi-function unit is equipped with digital and analog indicators.

The two analog indicators consist of a red and a green vertical LED array. One or two diodes light up alternately, with the measured value indicated by the center of the field.

The resolution of both indicators is 1.7 %. The green LED array on the right can be configured as a digital indicator, in which case digital signals are output to 10 equally spaced LEDs. Two of the three digital indicators have 4½-digit displays, and one has a 3-digit display. They can all be dimensioned in either engineering units or percentage.

13 additional LEDs are located on the front of the instrument to display status flags, alarm conditions etc. All LEDs can be connected as required.

Process operation (Fig. 7/2)

7 freely connectable pushbuttons are provided on the front panel, which are operator-accessible by pressing the curved foil.

All control and display elements (indicators, LEDs and input pushbuttons) on the front panel can be switched over to 4 data sources or sinks for multiple applications.

Customised descriptions can be inserted on the front panel.

The rating plate can also be replaced.

Description

Basic functions

A total of 32 basic functions can be used up to 109 times in any sequence: b01.F to bh9.F

- ncon Input not yet connected
- Hi; Lo; 1.00; Present for input; can be overwritten
- Hi High level
- Lo Low level

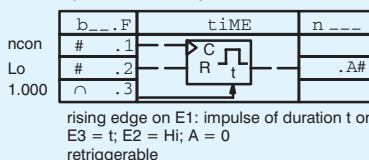
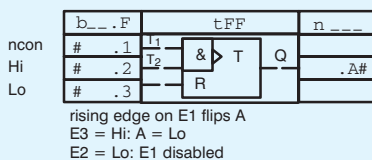
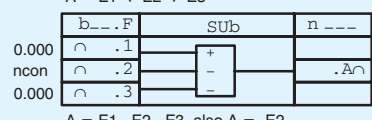
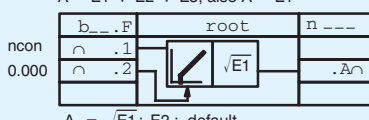
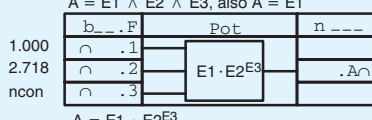
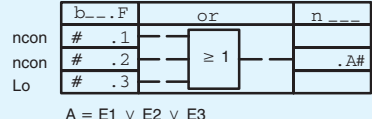
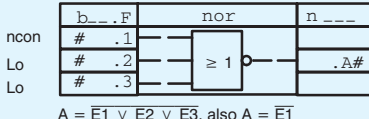
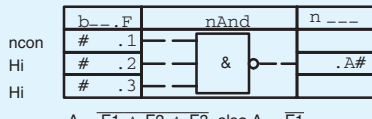
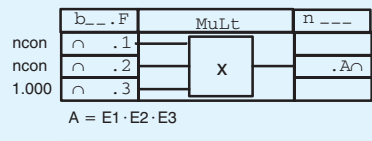
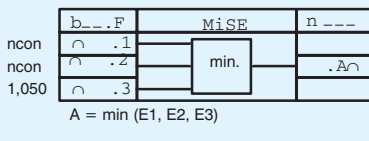
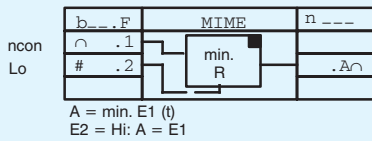
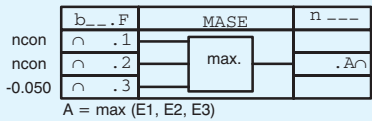
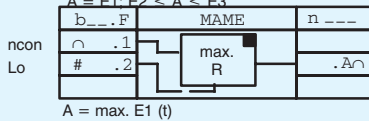
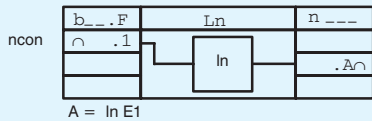
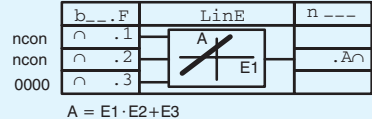
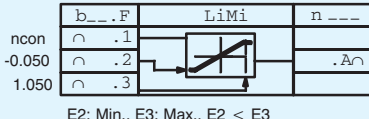
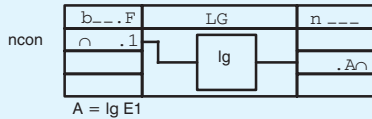
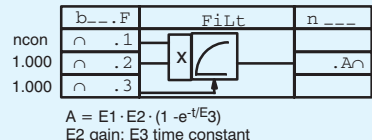
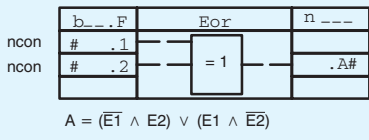
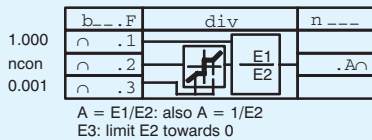
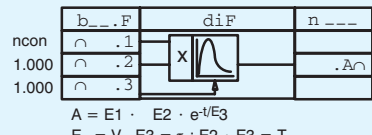
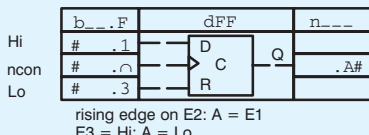
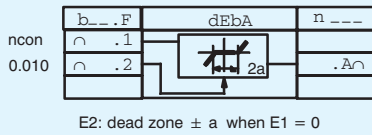
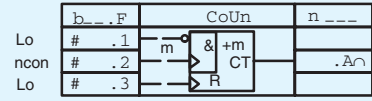
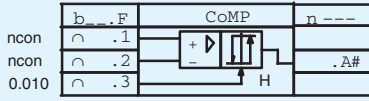
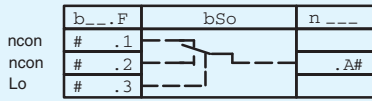
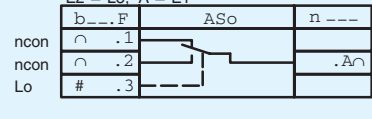
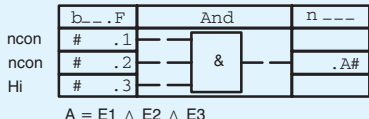
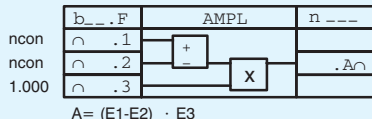
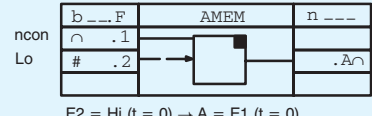
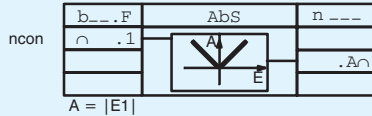
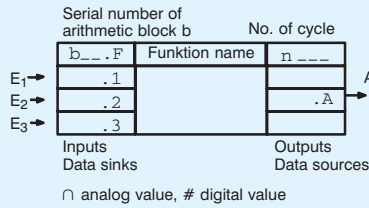

SIPART DR24 Multi-function Unit

6DR2410-

Description

Complex functions (functions with dedicated parameters)

Adaptive filters AFi1 and AFi2

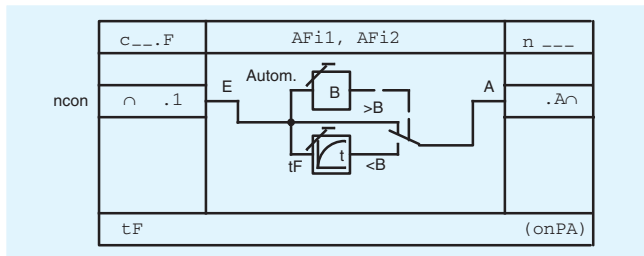

The adaptive filter AFi* dampens oscillations in the input variable, which occur repeatedly within a band *B*, using a variable time constant *tF*. Changes outside the band are applied unfiltered to the output. If the noise level changes, the band is automatically adapted to the new level. Noise – e.g. from a

Filter time constant
 $tF = \text{off}, 1 \text{ to } 9984 \text{ s}$

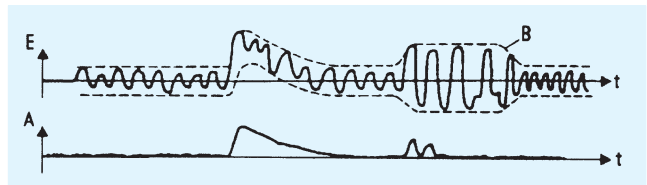

A Output signal B Filter band E Input signal
 Fig. 7/6 Effect of the adaptive non-linear filter

process variable – is thus suppressed without affecting the detection of rapid changes. This is important in controlled systems where rapid settling is required.

Dead-time elements dti1 and dti2

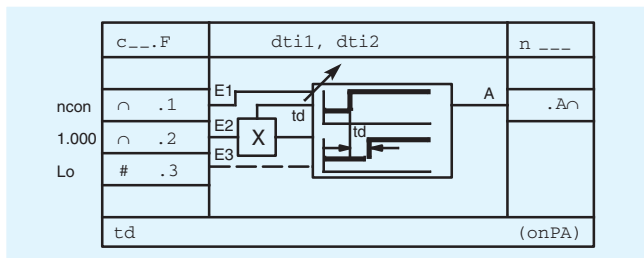

Output = input offset by time *td*:

Dead time t_d 1 to 9984 s
 Stored values 100/ t_d , max. 1/cycle

After "Power on": $A = 0$ for $t \leq t_d$

This dead time is multiplied with a factor in E2 and is therefore changed from outside. The dead time element can be "stopped" at any time via input 3. The profile remains during "standstill".
 E3 = Hi → "standstill".

Function generators FUP1 and FUP2

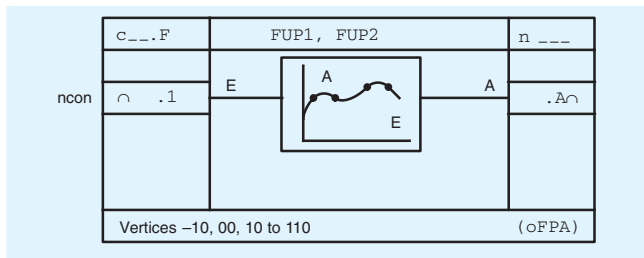

Curve calculator with 13 vertices between -10 and +110 % of the input signal range:
 parabolic approximation
 Output -199.9 to +199.9 %; magnitude per vertex can be parameterized.

Function generators FUL1, FUL2 and FUL3

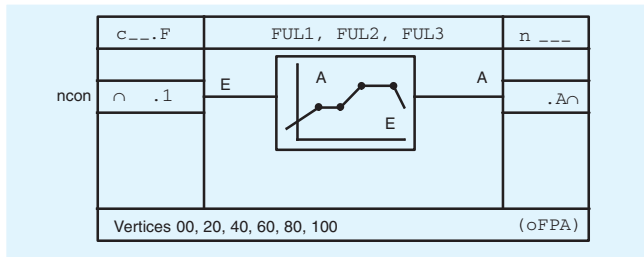

Curve calculator with 6 vertices between 0 and 100 % of the input signal range.
 The output function is formed by the straight sections between the vertices.
 The function generators can be used, for example, for parameter control in the controller function blocks *h_..F*.

Integrator with analog input Ain1 to Ain4

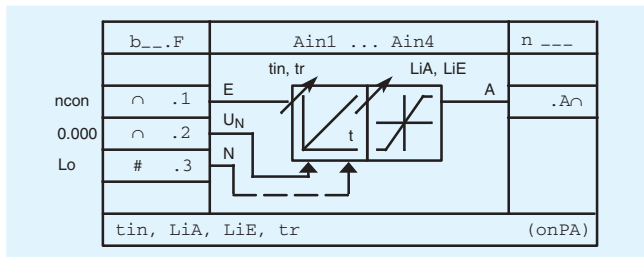

The analog variable on input .1 is integrated.
 Tracking mode ($N = \text{Hi}$): the memory *A* of the integrator is made to track the value of the analog variable U_N with t_r . Input .1 has no effect as long $N = \text{Hi}$. The integrator acts as an analog value memory when $E.1 = 0$ and $N = \text{Lo}$.

$$A = \frac{1}{t_{in}} \int E.1 dt + U_{No}$$

N Tracking signal
 U_N Tracking variable

t_{in} 1 to 9984 s Integrating time
 LiA -199.9 to +199.9 % Start-of-scale value
 LiE -199.9 to +199.9 % Full-scale value
 tr off, 1 to 9984 s Tracking time (ramp)

} memory limitation

Description

Integrator with digital inputs bin1 to bin6

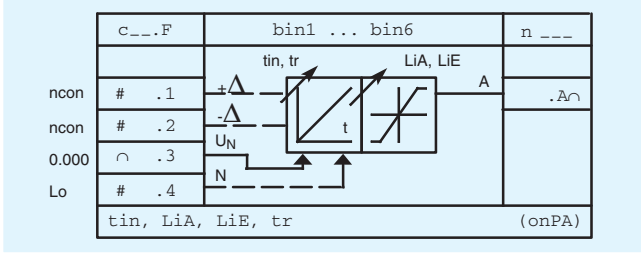

Digital input signals can be generated e. g. by pressing pushbuttons.

Possible applications:

- adjustment of analog values using front panel pushbuttons
- ramp functions.

The variables N and U_N enable the stored value to track external variable (U_N) with tr , e. g. for x -tracking, for adaptation of w_{int} to w_{ext} , or for adaptation of y_H to y_a for automatic, bumpless switchover when using the controller.

Integration is enabled by the digital signals on .1 or .2.

Tracking mode ($N = Hi$): memory A of the integrator is made to track the value of the analog variable U_N with tr . The inputs .1 and .2 have no effect as long as $N = Hi$.

The integrator acts as an analog value memory when $E.1 = 0$ and $E.2 = 0$ and $N = Lo$.

$$A = 1/tin \int E.1 dt + U_{No}$$

The integration time is progressive (100 % approx. 23 s) and constant when $tin = 1$ to 9984 s.

LiA	-199.9 to +199.9 %	Start-of-scale value	} memory limitation
LiE	-199.9 to +199.9 %	Full-scale value	
tr	off, 1 to 9984 s	Tracking time (ramp)	

Correction computers CPT1 and CPT2

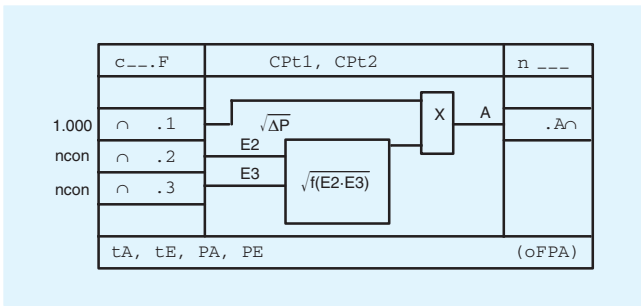

Correction computers are used to calculate the rate of flow of gases from the differential pressure p , correcting for fluctuations in pressure and temperature. Mass flow and volume flow based on the operational state can be corrected, as well as volume

flow based on standard state. The medium must be in a pure state, i. e. separation must not occur. The output variable A is calculated as follows:

$$A = \sqrt{\Delta p} \times \sqrt{f(E_2, E_3)}$$

$$f(E_2, E_3) = \frac{(P_E - P_A) E_2 + P_A}{(t_E - t_A) E_3 + t_A}$$

The measuring range is standardised to the formula using the parameters t_A, t_E, P_A and P_E . t_A and P_A can take a value between 0.01 to 1.000, t_E and P_E between 1.000 to 99.99.

This flow correction computer corrects errors caused by changes in the state variables of the medium (pressure, temperature).

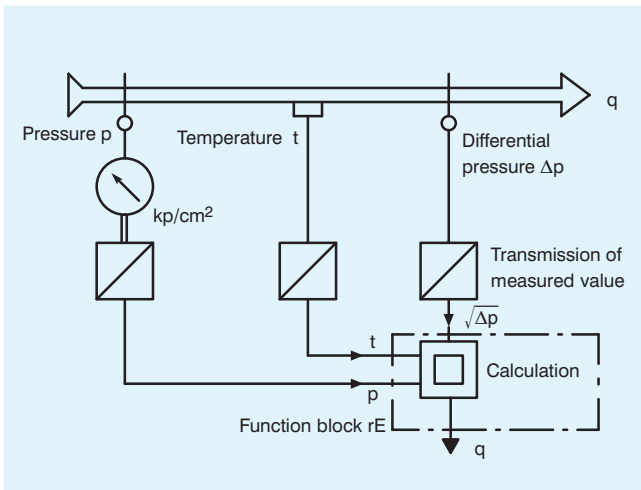

SIPART DR24 Multi-function Unit

6DR2410-

Description

Split range SPPr1 to SPPr8

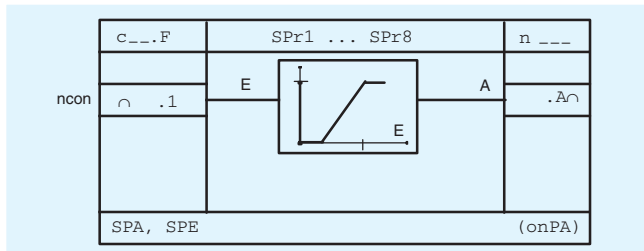

The split range function comprises a straight-line equation between the base point SPA (output value 0) and the turning point SPE (output value 1).

Outside this range, the output is limited to 0 or 1. By setting the two private onPA parameters SPA and SPE it is possible to implement both rising and falling sections.

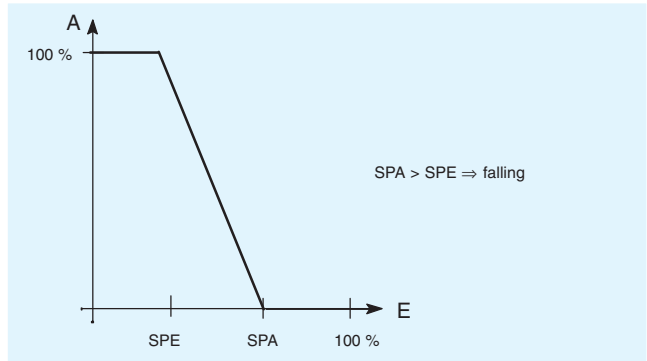
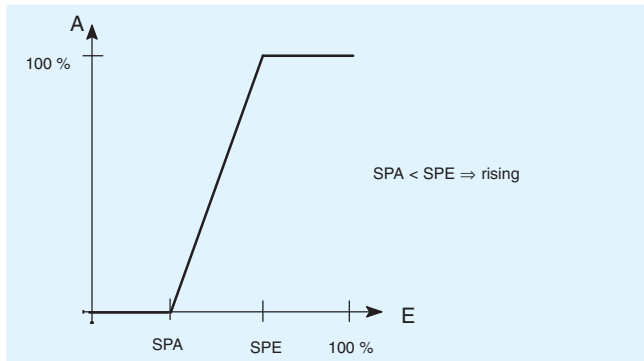

Pulse-width modulator

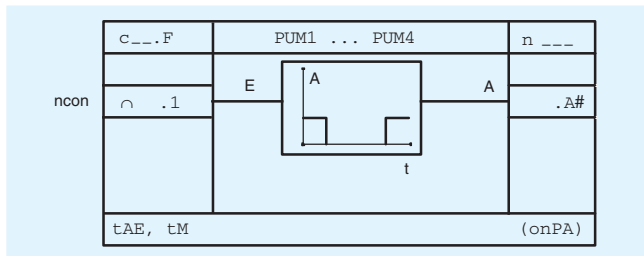

The pulse-modulator converts an analog signal into a pulse-width-modulated binary signal.

Private parameters (onPA)

- tM Period
- tAE Minimum on time

Example:

- Input value: 0.3
- Period: 4 s
- ⇒ On time 1.2 s
- Pause time 2.8 s

Measuring-point selector MUP1, MUP2 (multiplexer)

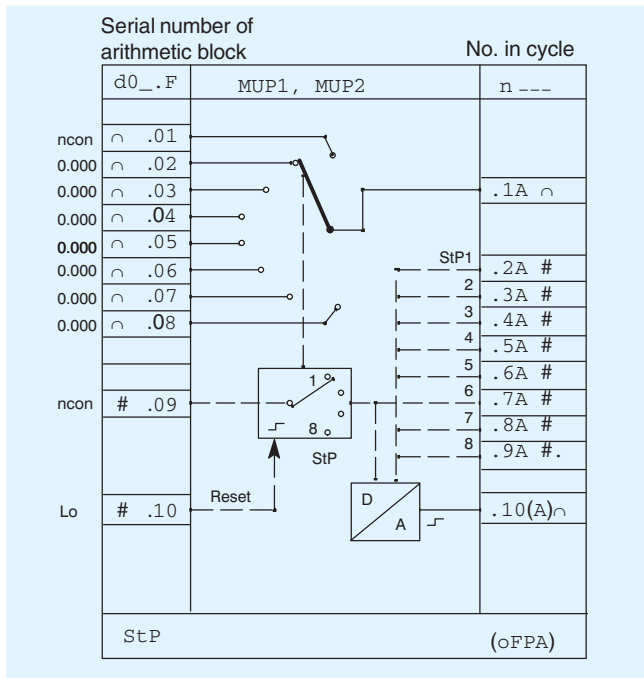

The multiplexer enables up to 8 analog inputs to be switched through to a single output. This switching operation is controlled by the signal on the cycle input d0*.09 (switch over in a closed ring). Each switching signal is indicated by a Hi signal on a separate output. These signals can, for example, be connected to the programmer's inputs to select a particular program. In addition, the current position can be displayed by connecting the d0*.10 output to the digital display dd3.

The StP parameter (number of switching steps) is used to select the maximum number of measuring points (2 to 8). The factory setting is 8.

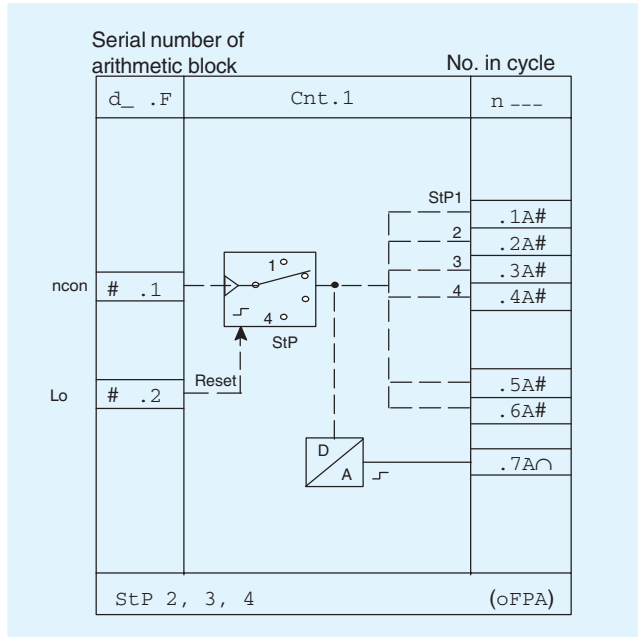
DescriptionDemultiplexer Cnt1

The demultiplexer is primarily used for switching over the display and control elements (multiple controller, max. 49).

It can be defined once. The demultiplexer is used to output the counter value in binary code according to the following table. Enabling is carried out controlled by the edge at the clock input $d^*.1$ (switching over in closed ring, limited by private parameter StP).

The counter can be set to position 1 by a High signal via the Reset input $d^*.2$. The position can be displayed by connecting the output to display $dd3$.

StP	1A	2A	3A	4A	5A	6A
1	1	0	0	0	0	0
2	0	1	0	0	1	0
3	0	0	1	0	0	1
4	0	0	0	1	1	1

Controller blocks Ccn1 to Ccn4, CSi1 to CSi4 and CSE1 to CSE4

Four of the controller blocks listed below can be used in each instrument, independent of the type of controller.

Input signal conditioning takes place outside the controller block. The controllers have inputs for the control deviation.

Inputs

- $h0^*.01$: Av Enable adaptation input
- $h0^*.02$: x Resulting controlled variable for adaptation
- $h0^*.03$: y_z Disturbance variable feedforward to manipulated variable y_a

- $h0^*.04$: x_{d_p}
 - $h0^*.05$: x_{d_i}
 - $h0^*.06$: x_{d_D}
- } control deviation inputs

The controlled variable or another process variable can be differentiated instead of the deviation x_d (dynamic disturbance variable feedforward)

- $h0^*.07$: P Control signal for changing structure
- P = Lo: PI, PID
- P = Hi: P, PD

P = Lo → PID (z):

$$y_a = y_z + x_{wP} \cdot K_P + x_{wI} \cdot K_P (1 + 1/j\omega T_n) + x_{wD} \cdot K_P \cdot j\omega T_v / (1 + j\omega T_v / N_v)$$

P = Hi → PD (z):

$$y_a = y_z + x_{wP} \cdot K_P + y_0 + x_{wD} \cdot K_P \cdot j\omega T_v / (1 + j\omega T_v / N_v)$$

- with $Y_0 = AUto$: Working point automatically adjusted in manual mode so that $Y_0 = Y_H$ in each case
- with $Y_0 \neq AUto$: Working point fixed at Y_0

- $h0^*.08$: H Control signal for switching operating mode of controller

H = Lo: $y = y_a$ (automatic mode)

H = Hi: $y = y_H$ (manual mode)

- $h0^*.09$: $+\Delta y$
 - $h0^*.10$: $-\Delta y$
- } Digital inputs for incremental adjustment of manipulated variables (tracking or manual mode)

- $h0^*.11$: $+y_{BL}$
 - $h0^*.12$: $-y_{BL}$
- } Digital inputs for direction-dependent blocking of manipulated variables

- $h0^*.13$: SG1
 - $h0^*.14$: SG2
 - $h0^*.15$: SG3
- } Controlled variable inputs for parameterized control of control parameters K_P , T_n and T_v .
- $h0^*.16$: N Digital input for manual or tracking mode
 - $h0^*.17$: Y_N Analog input for manual manipulated variable

Parameters

- cP Proportional gain
- tn Reset time
- tv Derivative action time
- vv Derivative action gain
- AH Response threshold
- Y_0 Working point
- Y_A Manipulated variable limitation, minimum
- Y_E Manipulated variable limitation, maximum
- t_Y Actuating time
- t_A Minimum pulse length
- t_E Minimum pulse interval

SIPART DR24 Multi-function Unit

6DR2410-

Description

K controller (with continuous output) Ccn 1 to Ccn4

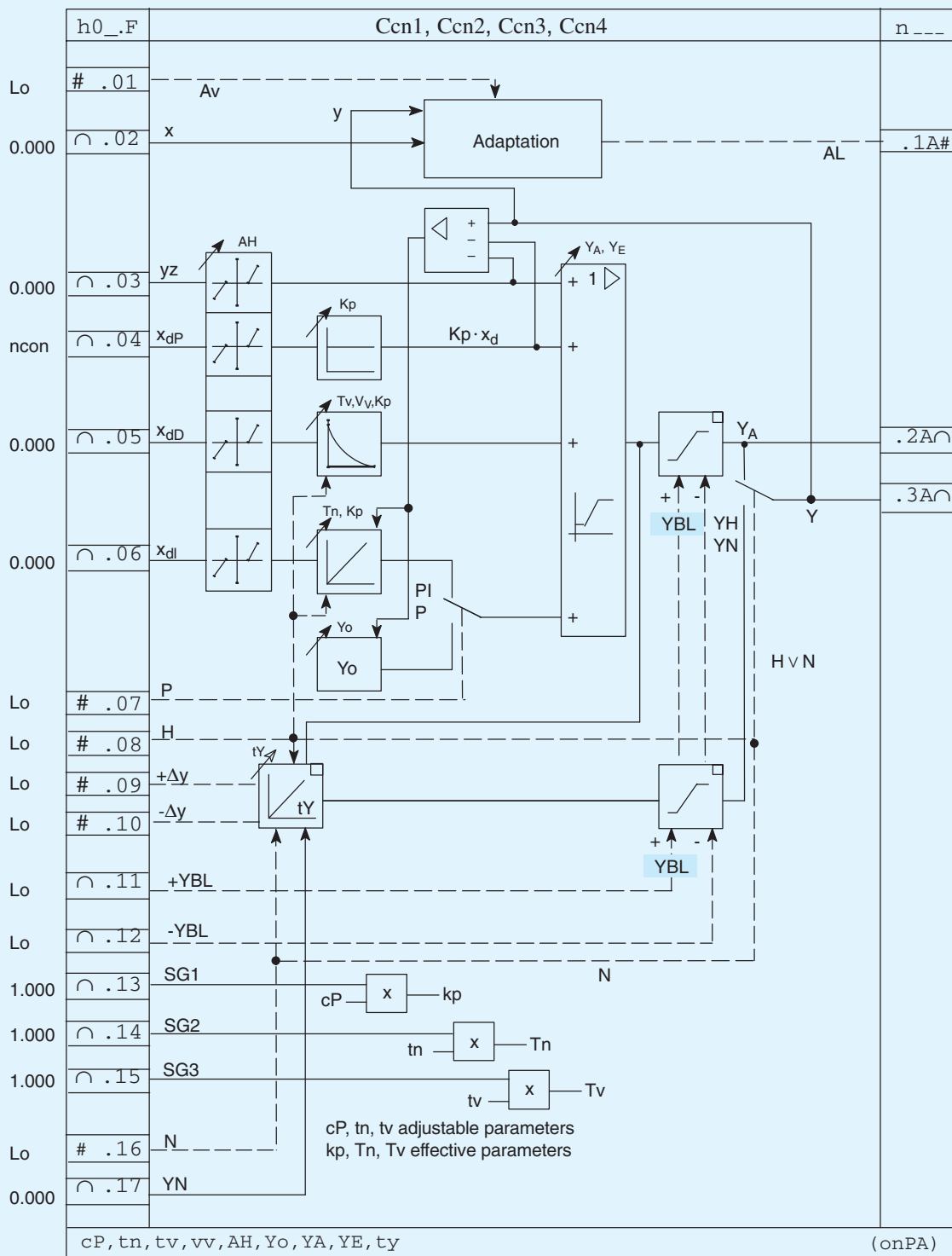

Outputs:

h0*.1A: Digital output signal "Adaptation in progress"

h0*.2A: Controller manipulated variable output signal (automatic mode)

h0*.3A: Manipulated variable output signal (manual, tracking or automatic mode)

Description

S controller (with three-position step controller and internal positional feedback) CSi1 to CSi4.

A positional feedback is not required with this controller, as the time response of the actuating motor is simulated by an integrator in the controller.

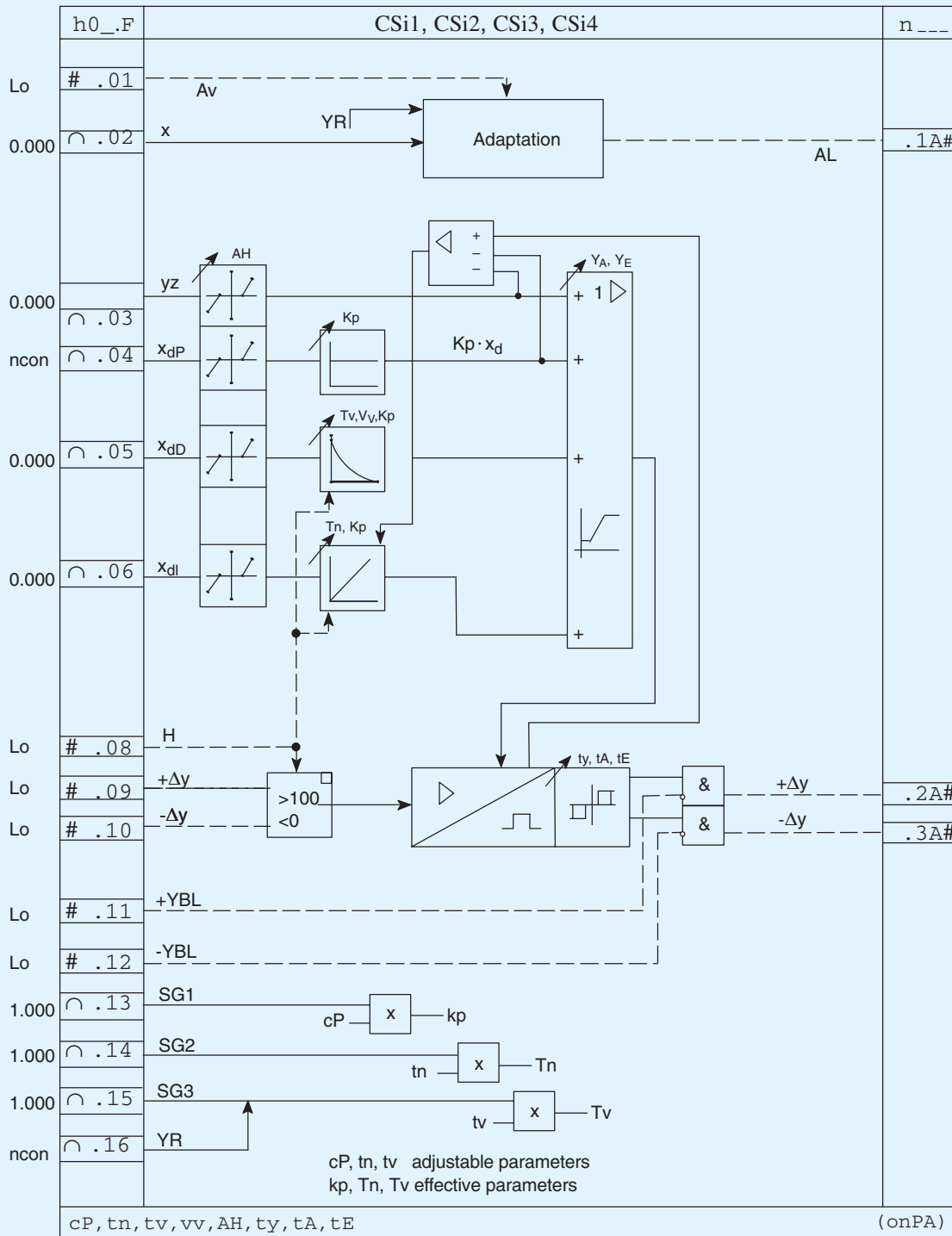

Outputs:

h0*.2A: +Δy
h0*.3A: -Δy } positional increments for the actuator
h0*.16: Y_R position feedback (for display only)

SIPART DR24 Multi-function Unit

6DR2410-.

Description

S controller (with three-position step controller and external positional feedback) CSE1 to CSE4

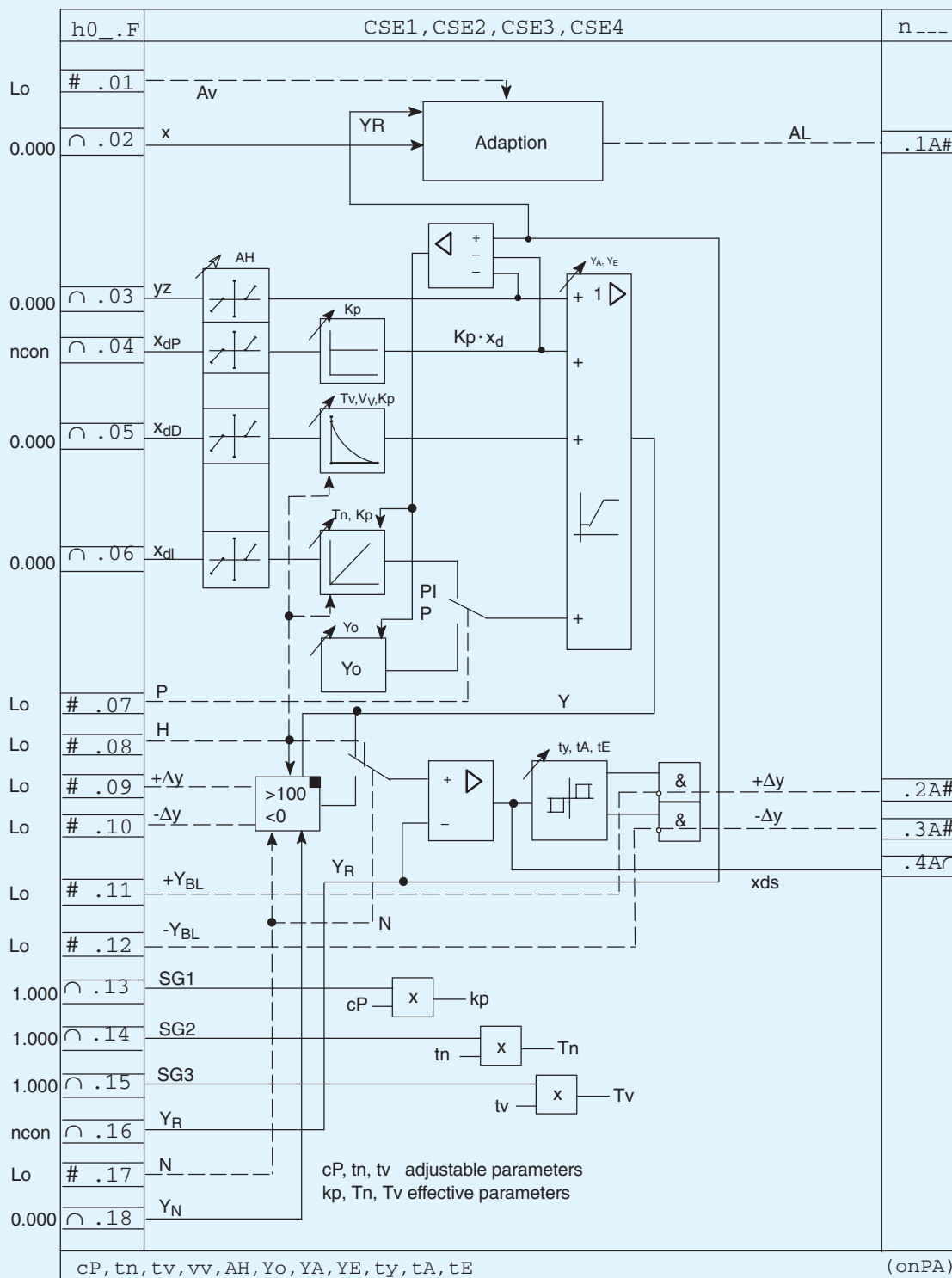

Outputs:

h0*.2A: +Δy
 h0*.3A: -Δy
 h0*.4A: xds
 h0*.16: Y_R

} positional increments for the actuator
 } control deviation of positional control loop
 } position feedback

Description

Programmers

The programmer enables 2 analog outputs and 8 digital outputs to be assigned a common time basis with a maximum of 40 time intervals. These 40 intervals can be divided among up to 8 independent programs, each of which is assigned an appropriate number of time intervals.

The time intervals for the programs are entered in the selected format in either h/min or min/s. The values of analog outputs and/or the status of digital outputs are then allocated to each time interval. The specified programs can be executed once, more than once, and also cyclically. The clock can also be speeded up for testing purposes.

The clock is controlled via the Start, Stop, Reset and High-speed inputs. The program to be executed is selected using the d0*.05 to d0*.12 inputs, and started by setting Start = Hi. The timing sequence can be monitored via the "time from start", "time in interval", "interval" and "stop clock" outputs.

Parameters

CLFo : Clock format: h/min or min/s

CLCY: Number of cycles

CLSb : Acceleration factor

Acceleration factor	Time			
	1 week	1 day	1 hr	1 min
360	28 min	4 min	10 s	-
168	60 min	-	-	-
120	84 min	12 min	30 s	0.5 s
60	168 min	24 min	1 min	1 s
24	7 h	1 h	2.5 min	2.5 s
12	14 h	2 h	5 min	5 s
6	28 h	4 h	10 min	10 s
3	56 h	8 h	20 min	20 s

CLPr : Number of intervals/program

CLti : Length of interval

CLA1, 2 : Analog output value 1 or 2

CLb1 to

CLb8 : Digital status Hi or Lo in respective interval

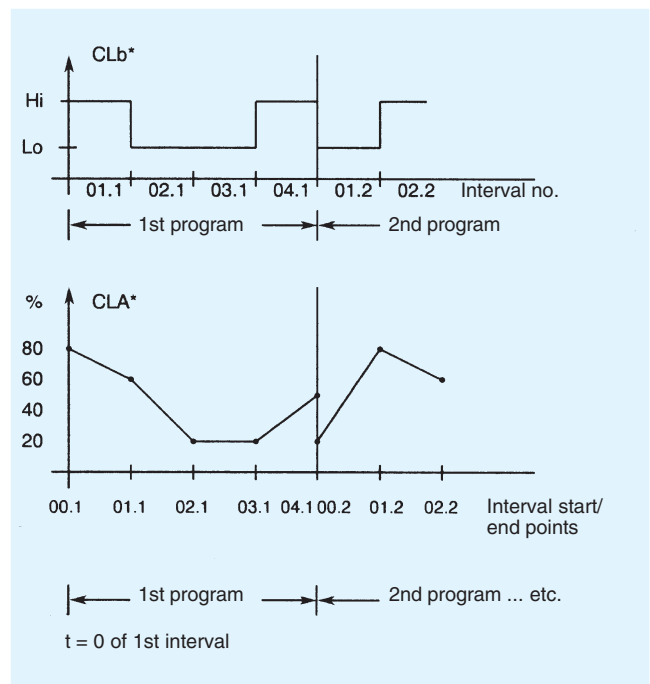
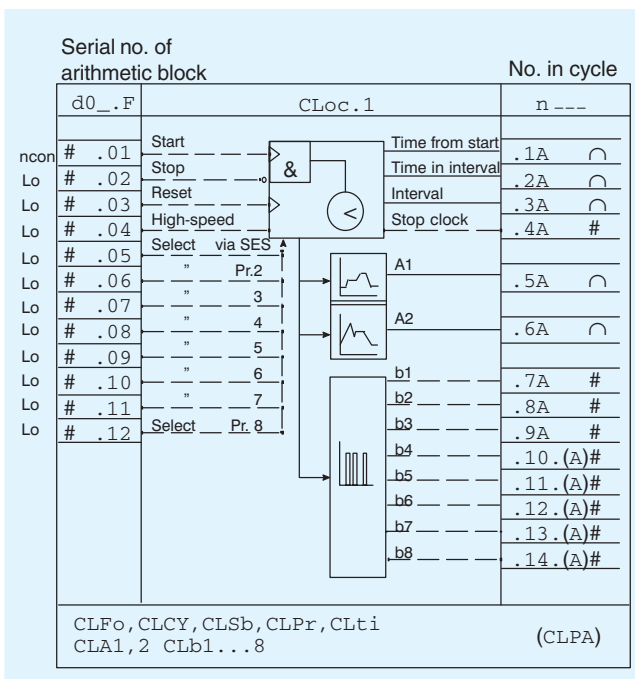

Interval	CLA..	CLb..	Meaning of interval indicator		
			with CLA	with CLb	
00.1	80 %	-	↑	Start 1st interv. (t=0)	-
01.1	60 %	Hi	↑	End 1st interval	1st interval
02.1	20 %	Lo	1st progr.	End 2nd interval	2nd interval
03.1	20 %	Lo	↓	End 3rd interval	3rd interval
04.1	50 %	Hi	↓	End 4th interval	4th interval
00.2	20 %	-	↑	Start 1st interv. (t=0)	-
01.2	80 %	Hi	↑	End 1st interval	1st interval
02.2	60 %	Lo	2nd progr.	End 2nd interval	2nd interval

Interval no. in display dd3 Program no. in display dd3

SIPART DR24 Multi-function Unit

6DR2410-

Description

Serial interface

Input and output functions of the serial interface

Freely connectable inputs and outputs (SAE, SbE and SAA, SbA respectively) and dedicated read-only inputs and outputs (AI, DI and AO, DO respectively) of the multi-function unit can be read/written by the SES. Parameters and configuring data can also be read/written.

The data sinks SA(E).1 (tracking variable) and SA(E).2 (tracking control signal) are used to track the data source SA.3 if a

bumpless changeover towards (SA(E).3 is to be made between this data source and another.

A cyclical watch-dog function can be used to monitor traffic on the interface. A monitoring period can be specified using the parameter Cbt; when the elapsed time between two telegrams exceeds this period, the digital input SbE1 is set to Lo. If required, this could be used to trigger changeovers within the multi-function unit.

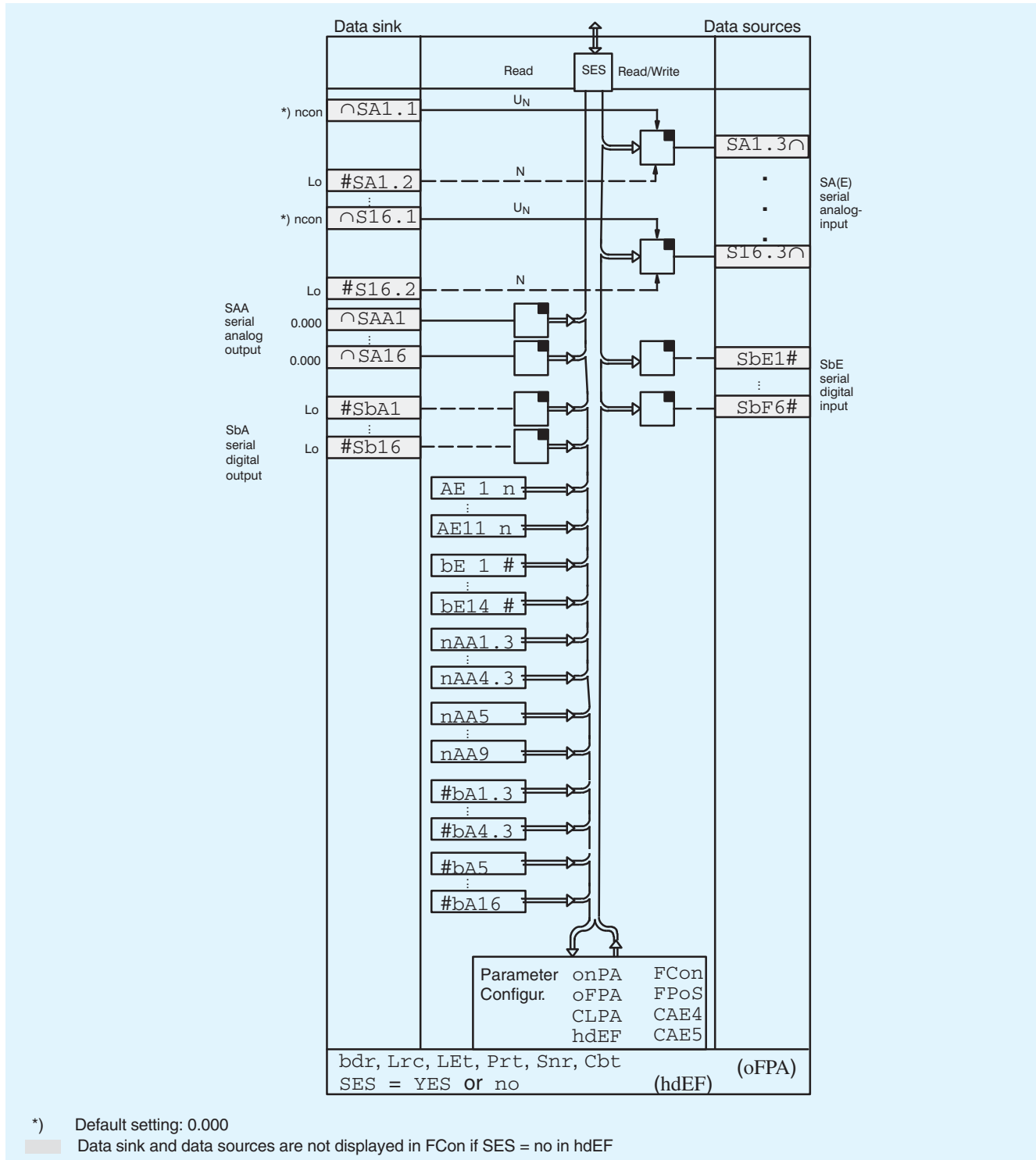

SIPART DR24 Multi-function Unit

6DR2410-.

Technical data

Technical data	
General data	
Mounting position	Any
Climatic classes	
- Storage: 1K2 according to DIN IEC 721 Part 3-1	-25 to +75 °C
- Transport: 2K2 according to DIN IEC 721 Part 3-2	-25 to +75 °C
- Operation: 3K3 according to DIN IEC 721 Part 3-3	0 to +50 °C
Degree of protection to EN 60 529	
Front module	IP 64
Housing	IP 30
Connections	IP 20
Controller design	
Electrical safety	
- to DIN EN 61 010 Part 1	
- Protection class I	
- Safety separation between supply connection and field signals	
- Clearances and creepage paths for surge class III and pollution level 2 , unless stated otherwise	
EC Certificate of Conformity no. 691.001	
CE marking	conformity concerning
	- EMC Guideline 89/336/EWG and
	- NS Guideline 73/23/EWG
Emitted interference, immunity to interference to EN 61 326, NAMUR NE21 8/98	
Weight, standard device without options	Approx. 1.2 kg
Colour	
Front module frame	RAL 7037
Front surface	RAL 7035
Material	
Housing and front frame	Polycarbonate, reinforced with fiber glass
Front foil	Polyester
Power supply connection	
AC 115/230 V	3-pin earthed plug IEC 320/V
AC/DC 24 V	Special 2-pin plug
Process signal connections	Multiple screw terminal blocks, cannot be confused when connecting, for conductor cross-section 1.5 mm ² (AWG 14)
Protective earth connection	Earth screw
A rail can be mounted on the rear panel of the power supply. The rail is included in the delivery of the coupling relay mode.	

Power supply				
Rated voltage	Switchable		AC/DC 24 V	
	AC 230 V	AC 115 V	AC 20 to 28 V	DC 20 to 35 V 4)
Operating voltage range	AC 187 to 276 V	AC 93 to 138 V	AC 20 to 28 V	DC 20 to 35 V 4)
Frequency range	48 to 63 Hz			-
Peak voltages not periodic to VDE 160				
1.3 ms	≤ 780 V	≤ 390 V	≤ 70 V	
10 μs	≤ 1500 V	≤ 1500 V	≤ 500 V	
External current I _{ext} ⁵⁾	450 mA			
Power consumption				
Active power/ apparent power 6)				
Stand. contr.				
- without options, without I _{Ext}	8 W/17 VA	8 W/13 VA	8 W/11 VA	8 W
- with options, without I _{Ext}	13 W/25 VA	13 W/20 VA	13 W/18 VA	13 W
- with options, with I _{Ext}	26 W/45 VA	26 W/36 VA	28 W/35 VA	28 W

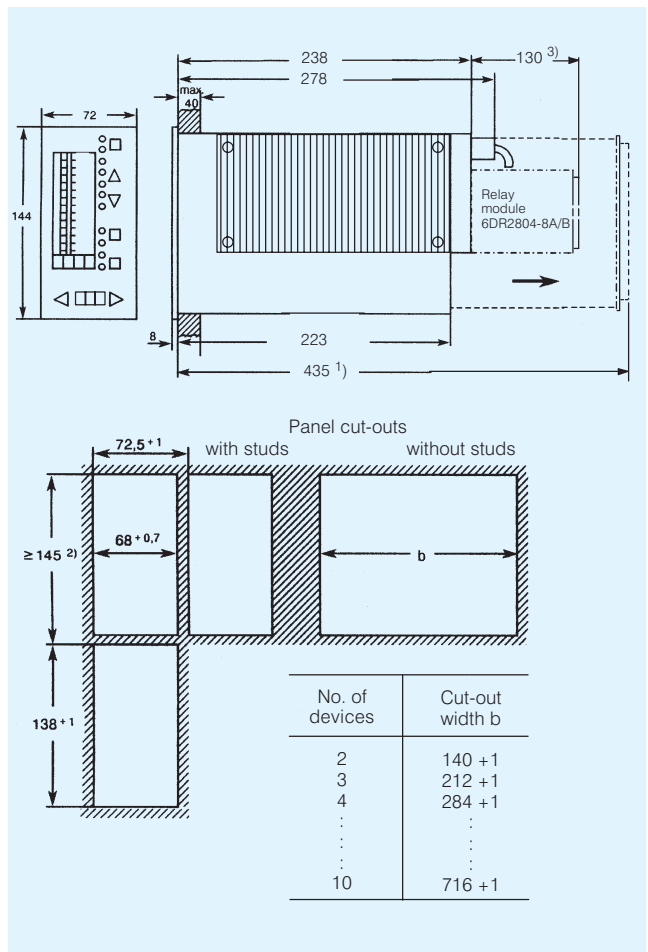

1) Space required for removal of main circuit board.
 2) Observe permitted ambient temperature when stacking without intermediate spacing.
 3) A relay module containing 2 or 4 relay contacts (6DR2804-8A/-8B) can be snapped onto the rear of the multi-function unit, in which case the mounting depth increases by 130 mm.
 4) Includes harmonic content.
 5) Derived from L+, BA and AA.
 6) Capacitive.

Fig. 7/7 SIPART DR24 multi-function unit and panel cut-outs, dimensions

SIPART DR24 Multi-function Unit

6DR2410-.

Technical data

Technical data (continued)

Power supply (continued)

Permitted voltage dips ¹⁾ Stand. contr. - without options, without I_{Ext}	≤ 90 ms	≤ 70 ms	≤ 55 ms	≤ 30 ms
- with options, without I_{Ext}	≤ 80 ms	≤ 60 ms	≤ 50 ms	≤ 25 ms
- with options, with I_{Ext}	≤ 50 ms	≤ 35 ms	≤ 35 ms	≤ 20 ms

Test voltages (1 min) - primary - secondary	AC 1.5 kV	AC 500 V
- primary - prot. cond.	AC 1.5 kV	AC 500 V
- secondary - prot. cond.	DC 700 V	DC 700 V

Inputs and outputs, display technology

• Analog inputs AE1, AE2, AE3 and AE6 to AE11 (input module 6DR2800-8A)

Input signal range	0/199.6 to 998 mV or 0/2 to 10 V
Voltage	0/4 to 20 mA
Current	
Input impedance	
Differential (voltage)	200 kΩ
Differential (current)	49.9 Ω ± 0.1 %
Common-mode	> 500 kΩ
Common-mode voltage	0 to 10 V
Filter time constant	50 ms
Effect of temperature	
Zero	0.05 %/10 K
Gain	0.1 %/10 K

• Analog outputs AA1 to AA3

Rated signal range	0/4 to 20 mA
Operating range	0 to 20.5 mA or 3.6 to 20.5 mA
Load voltage	-1 to +18 V
Max. inductive load	≤ 0.1 H
No-load voltage	≤ 26 V
Time constant	300 ms
Residual ripple 900 Hz	≤ 0.2 %
Resolution	≤ 0.1 %
Zero error	≤ 0.3 % of measuring span
Gain error	≤ 0.3 % of measuring span
Linearity error	≤ 0.05 % of measuring span
Load dependence	≤ 0.1 %
Effect of temperature	
Zero	≤ 0.1 %/10 K
Gain	≤ 0.1 %/10 K

• Transmitter supply L+

Rated voltage	20 to 26 V
On-load current	≤ 100 mA, short-circuit proof
Short-circuit current	≤ 200 mA pulsed

• Digital inputs BE1 to BE4

Signal status 0	≤ 4.5 V or open
Signal status 1	≥ 13 V
Static destruction limit	± 35 V
Input impedance	≥ 27 kΩ

• Digital outputs BA1 to BA8 (connected via Wired-OR diodes)

Signal status 0	≤ 1.5 V
Signal status 1	19 to 26 V
On-load current	≤ 50 mA
Short-circuit current	≤ 80 mA pulsed

• Cycle time	> 60 ms, user program dependent
--------------	---------------------------------

• A/D conversion

Method	Successive approximation with > 120 measurements per input and averaging over 20 or 16.67 ms 11 bit = 0.06 %
Resolution	
Zero error	≤ 0.2 % of the measuring span
Gain error	≤ 0.2 % of the measuring span
Linearity error	≤ 0.2 % of the measuring span
Effect of temperature	
Zero	≤ 0.05 %/10 K
Gain	≤ 0.1 %/10 K

• Parameters

Adjusting Rate	tA 2/3 (more-less)
Precision	
Time parameters	≤ ± 0.05 % throughout the complete temperature range
All others	Absolute, depending on resolution

• Display technology

Digital dd1, dd2 displays	4½ digit, 7-segment LEDs
Colour dd1	Green
dd2	Red
Digit height	7 mm
Display range	Adjustable start-full scale
Numeric range	-1999 to 19999
Decimal point	Variable
Refresh rate	1 to 100 cycles/display
Resolution	1 digit, but not better than A/D converter
Display error	Corresponding to A/D converter and analog inputs
Digital dd3 display	3-digit, 7-segment LEDs
Colour	Yellow
Digit height	7 mm
Display range	Adjustable start-full scale
Numeric range	-199 to 999
Decimal point	Variable
Refresh rate	1 to 100 cycle/display, variable
Resolution	1 digit, but not better than A/D converter
Display error	Corresponding to A/D converter and analog inputs
Analog dA1, dA2 displays	
Colour dA1	Red
dA2	Green
Display range	LED array with 30 LEDs
Signal range	-199.9 to 199.9 %, variable
Overflow	< -0.85 % of display range; 1st LED flashes > 100.85 % of display range; 30th LED flashes
Resolution	1.7 % by alternate lighting of 1 or 2 LEDs, the centre point of the illuminated LEDs acting as a pointer
Refresh rate	Cyclic

¹⁾ Load voltage of analog outputs thereby reduced to 13 V, L+ reduced to + 15 V and voltage on digital outputs drops to + 14 V.

SIPART DR24 Multi-function Unit

6DR2410-.

Ordering data	
Ordering data	
	Order No.
SIPART DR24 multi-function unit 72 x 144, basic unit with - 3 analog inputs - 3 analog outputs - 4 digital inputs - 8 digital outputs - user program memory • for AC/DC 24 V power supply • for switchable AC 230/115 V supply	6DR2410-4 6DR2410-5
Input/output modules Analog signal module - for current input 0/4 to 20 mA or voltage inputs 0/0.2 to 1 V or 0/2 to 10 V (6DR2800-8J) - for resistance based sensor (R module) (6DR2800-8R) - for TC/RTD/R/mV signals, programmable (UNI module) (6DR2800-8V) - Reference junction terminal for TC, internal (to be used in conjunction with UNI module (6DR2805-8A) - Measuring range connector for $I = 20 \text{ mA}$ and $U = 10 \text{ V}$ (to be used in conjunction with UNI module) (6DR2805-8J) - with 3 analog outputs 0/4 to 20 mA and 3 binary inputs (6DR2802-8B) - with 3 analog inputs 0/4 to 20 mA or 0/0.2 to 1 V or 0/2 to 10 V (6DR2800-8A) - y-hold module (6DR2802-8A) Switching signal module - with 5 digital inputs (6DR2801-8C) - with 4 digital outputs and two digital inputs (6DR2801-8E) - with 2 relay outputs (6DR2801-8D) Coupling relay module - With 4 relays (AC 250 V) (6DR2804-8A) - With 2 relays (AC 250 V) (6DR2804-8B) Interface modules - For serial communications via RS 232 or RS 485 (6DR2803-8C) - PROFIBUS-DP module (6DR2803-8P)	See Catalog Section 8
Documentation SIPART DR24 multi-function unit manual - German - English Mounting and installation instructions, German/English www.siemens.com/sipartdr www.siemens.com/sipartdr www.siemens.com/sipartdr Additional Instructions can be downloaded from Internet (www.siemens.com/sipartdr) SIPART DR PROFIBUS interface / Instructions (Description of the communication via PROFIBUS DP with the controller SIPART DR19/20/21/22/24) - German - English SIPART DR24 Serial SIPART 6DR24 Bus interface / Instructions (Description of the communication via RS 232, RS 485 or PROFIBUS DP with the controller SIPART DR24) - German - English Scope of supply The scope of supply of a DR24 multi-function unit includes: 1 multi-function unit as ordered 1 power supply connector 115/230 V or a special connector for 24 V AC/DC supply 2 clamping elements, pluggable 1 CD-ROM with complete documentation Available ex-stores Items marked  are available ex-stores.	
Input/output modules and accessories The input/output modules are described in Catalog Section 8. Section 9 of the catalog contains details about software for parameterizing the multi-function unit from a PC, interfacing to systems and the necessary accessories (connectors, line drivers, etc.).	

SIPART DR24 Input/Output Modules

6DR2410-.

Overview: applications

Analog signal modules	SIPART DR24					Description see Section 8, Page
	Slot 2	Slot 3	Slot 4	Slot 5	Slot 6	
U/I module 6DR2800-8J	AI4	AI5	-	-	-	8/3
3 x U/I module 6DR2800-8A	-	-	-	AI9/10/11	AI6/7/8	8/4
R module 6DR2800-8R	AI4	AI5	-	-	-	8/5
Pt 100 module 6DR2800-8P	(AI4)*	(AI5)*	-	-	-	8/6
TC module 6DR2800-8T	(AI4)*	(AI5)*	-	-	-	8/7
UNI module 6DR2800-8V (TC/RTD/R/U/I)	AI4	AI5	-	-	-	8/8
y-hold module 6DR2802-8A	-	-	-	AO7	AO4	8/10
3AO/3DI module 6DR2802-8B	-	-	-	AO7/8/9 DI5/6/7	AO4/5/6 DI10/11/12	8/11

NEW

*) Use the UNI module 6DR2800-8V.

Switching signal modules	SIPART DR24					Description see Section 8, Page
	Slot 2	Slot 3	Slot 4	Slot 5	Slot 6	
5 DI 6DR2801-8C	-	-	-	DI5/6/7/8/9	DI 10/11/12/13/14	8/12
2 relays 6DR2801-8D	-	-	-	DO9/10	DO13/14	8/13
4DO/2DI 6DR2801-8E	-	-	-	DO9/10/11/12 DI5/6	DO13/14/15/16 DI10/11	8/14

Interface module	SIPART DR24					Description see Section 8, Page
	Slot 2	Slot 3	Slot 4	Slot 5	Slot 6	
SES module 6DR2803-8C						8/15
RS 232/SIPART bus	-	-	Yes	-	-	
RS 485	-	-	Yes	-	-	
PROFIBUS-DP module 6DR2803-8P	-	-	Yes	-	-	8/16

NEW

Coupling relay module can be installed on rear:	SIPART DR24	Description see Section 8, Page
with 4 relays 6DR2804-8A	Yes	8/17
with 2 relays 6DR2804-8B	Yes	8/17

Depending on the application, the following can be used in conjunction with the UNI module 6DR2800-8V:	Description see Section 8, Page	
Reference junction terminal 6DR2805-8A	8/8	
Measuring range connector 6DR2805-8J	8/8	