

Instruction Manual • September 2003

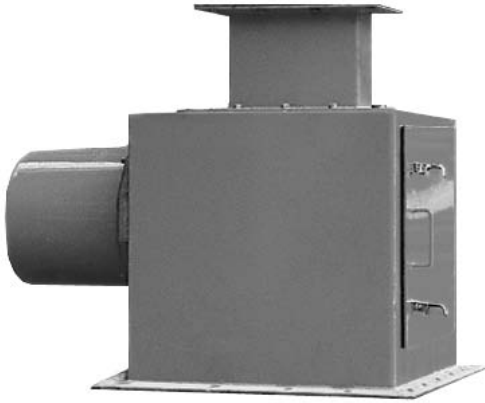

milltronics

V SERIES

SIEMENS

Safety Guidelines

Warning notices must be observed to ensure personal safety as well as that of others, and to protect the product and the connected equipment. These warning notices are accompanied by a clarification of the level of caution to be observed.

Qualified Personnel

This device/system may only be set up and operated in conjunction with this manual. Qualified personnel are only authorized to install and operate this equipment in accordance with established safety practices and standards.

Warning: This product can only function properly and safely if it is correctly transported, stored, installed, set up, operated, and maintained.

Note: Always use product in accordance with specifications.

Copyright Siemens Milltronics Process Instruments Inc. 2003. All Rights Reserved

Disclaimer of Liability

This document is available in bound version and in electronic version. We encourage users to purchase authorized bound manuals, or to view electronic versions as designed and authored by Siemens Milltronics Process Instruments Inc. Siemens Milltronics Process Instruments Inc. will not be responsible for the contents of partial or whole reproductions of either bound or electronic versions.

While we have verified the contents of this manual for agreement with the instrumentation described, variations remain possible. Thus we cannot guarantee full agreement. The contents of this manual are regularly reviewed and corrections are included in subsequent editions. We welcome all suggestions for improvement.

Technical data subject to change.

MILLTRONICS® is a registered trademark of Siemens Milltronics Process Instruments Inc.

Contact SMPI Technical Publications at the following address:

Technical Publications
Siemens Milltronics Process Instruments Inc.
1954 Technology Drive, P.O. Box 4225
Peterborough, Ontario, Canada, K9J 7B1
Email: techpubs@siemens-milltronics.com

For the library of SMPI instruction manuals, visit our Web site: www.siemens-milltronics.com

Table of Contents

Milltronics V Series Solids Flowmeters	1
The Manual.....	1
Specifications	2
Installation	3
Location	3
Applications	4
Materials	4
Material Feed	4
Flowmeter In-Feed Chutes	6
Maintenance	8
V-40 Outline and Mounting	9
V-300 Outline and Mounting	10

Milltronics V Series Solids Flowmeters

The Milltronics V Series solids flowmeters are compact vertical, low- to medium-capacity flowmeters for various product sizes, densities and fluidities, particularly fine powders.

Material entering the flowmeter flowguide drops vertically toward the angled sensing plate. For accurate, repeatable results, ensure the material flow is properly conditioned. See Material Feed on page 4 for more information.

The V-40 flowmeter is equipped with an ILE-37 sensing head and is suitable for material flowrates up to 40 t/h (44 STPH). The V-300 flowmeter with an ILE-61 sensing head is suitable for up to 300 t/h (330 STPH).

The flowmeter sensing head LVDT output signal is processed by the flowmeter integrator (ordered separately) to:

- monitor material flow
- maintain accurate material inventory
- provide batch control for process or loadout purposes¹
- control the ratio of materials in continuous blending processes¹

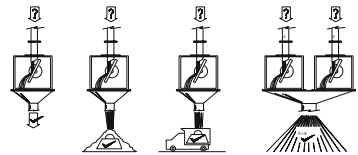
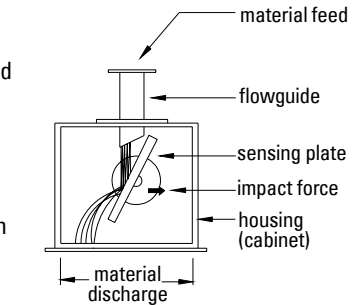

Components of the Milltronics V Series flowmeter system:

- V series flowmeter housing and flow guide
- ILE-37 or ILE-61 sensing head (ordered separately)
- stainless steel sensing plate (ordered separately)
- electronic flowmeter integrator (ordered separately)

The Manual

This instruction manual covers the installation, operation and maintenance of the V Series solids flowmeter.

Please refer to this manual for proper installation and operation of any component of the system to which the Milltronics V Series is being applied. Adhering to the installation and operating procedures will ensure a quick, trouble-free installation and allow for the maximum accuracy and reliability of your weighing system. Because the Milltronics V Series flowmeter is used in conjunction with an integrator and sensing head, refer to the instruction manuals for those devices as well.

If you have any questions, comments, or suggestions about the manual contents, please email us at techpubs@siemens-milltronics.com.

For the complete library of Siemens Milltronics manuals, go to www.siemens-milltronics.com.

¹. additional equipment required

Specifications

Model

- V-40
- V-300

Particle Size

- V-40: fine powder to 13 mm (0.5")
- V-300: fine powder up to 25 mm (1")

Product Temperature

- -40 to 232 °C (-40 to 450 °F)
- -40 to 400 °C (-40 to 750 °F) (optional)

Ambient Temperature

- -40 to 60 °C (-40 to 140 °F)

Accuracy

- ± 1 %, 33 to 100 % of design capacity; extended accuracy range with linearization function of integrator

Repeatability

- ± 0.2 %

Capacity Range

- V-40: 0.2 to 40 t/h (0.2 to 44 STPH)
- V-300: 20 to 300 t/h (22 to 330 STPH)

Construction

- painted mild steel flowguide and sensing plate housing(cabinet) and AISI 304 (1.4306) stainless steel sensing plate
- optional special materials and coatings for flowguide and sensing plate
- V-40: ILE-37¹ sensing head, cast aluminum with fibreglass cover
- V-300: ILE-61 sensing head, cast aluminum with fibreglass cover

Approvals

- CSA certified, general purpose (sensing head)
- CE²

Options

- 304 (1.4301) or 316 (1.4404) stainless steel housing and flowguide assembly
- PTFE or Abrasion Resistant flowguide lining
- CSA Class I, Groups C and D; Class II, Groups E, F, and G (sensing head)

-
1. The ILE-37 is available in side mount version (supported by the housing) or base mount version (supported separately from the housing).
 2. EMC performance available upon request.

Installation

Location

Install the V Series flowmeter in an area that is suitable for the system approval rating. Position the flowmeter to permit opening the sensing plate housing door for sensing plate access, and removing the sensing head rear cover for calibration purposes

Ensure the flowmeter inlet and outlet mounting points are free from vibration. If vibration is expected, use a base mounted sensing head if using the Milltronics V-40.

1. Position the flowmeter into the desired location.
2. If necessary, shim the housing base to level.
3. Fasten the housing discharge to the downstream material chute.
4. Fasten the flowguide to the material infeed chute.
5. Refer to ILE-37 or ILE-61 sensing head instruction manuals for sensing head installation, levelling, sensing plate installation, and integrator interconnection instructions.

Note: Provide sufficient mechanical support for the flowmeter and chutework.

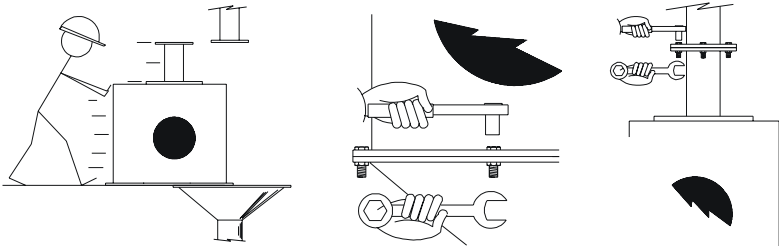

Applications

Note: For best performance and limited maintenance requirements, keep in mind material compatibility and flow patterns.

Materials

Material characteristics for best results:

- low cohesion (flows well through chutes, like a liquid)
- low adhesion (does not stick to surfaces)
- low abrasion (will not wear out chutes, flowguide, or sensing plate)
- low causticity (will not damage internal flowmeter components)

Most materials with low moisture content have excellent flow and adhesion characteristics. In processes where material moisture content varies, select a flowmeter location where the moisture content is lowest.

Use sensing plate and flowguide non-stick linings for ammonium nitrate, cocoa, fertilizer, wheat flour, gluten, laundry detergent, sugar, and other materials with similar properties.

Abrasive materials are best monitored at low velocity. Use sensing plate and flowguide abrasion resistant linings for alumina, asbestos, barley, carbide, corn, clinker, limestone, perlite ore, and other materials with similar hardness, and particle mass.

Standard flowmeter components are resistant to chemical reaction with most materials. Use special paint or coatings on exposed flowmeter components for ammonium nitrate, carbide, fertilizer, phosphate, salt, sodium chloride, sodium sulphate, and other materials with similar properties.

Material Feed

Ideal material infeed characteristics:

- constant and relatively low material velocity
- uniform material flowrate (not pulsing)
- negligible air flow through the flowmeter
- flowguide 17 to 50 % full during operation

For best results, use material from an elevated bin, gravity fed to the flowmeter. If the material is to be monitored after some process has been performed, choose the feeder device that provides the most consistent material flow.

Use a reverse flowguide transition when high or variable velocity feeder material discharges are anticipated. Refer to Flowmeter Infeed Chutes on page 6. Position the flowmeter discharge chute so material cannot back up into the flowmeter housing.

Use a heavier flowmeter sensing head range spring and/or viscous damper fluid to compensate for slight to moderate material pulsing at greater than 1 pulse per second. For heavily pulsing feeder discharges, at less than 1 pulse per second, consult your local Siemens Milltronics representative.

Screw Conveyor

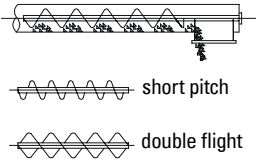

- most common type of material feeder
- short pitch and/or double flight screws preferred to reduce the batch size (and increase the frequency) of the material discharge pulse, or cut back the flights of a standard screw so it ends before the discharge opening
- use reverse flowguide transition for variable operating speeds or constant speeds above 40 rpm

Rotary Feeder

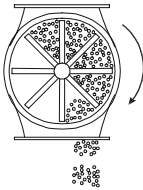

- provides an air seal between the upstream and/or downstream process, and the flowmeter
- required if the material is pneumatically conveyed or flowmeter/process isolation is required
- use reverse flowguide transition for variable operating speeds or constant speeds above 10 rpm

Bucket Elevators

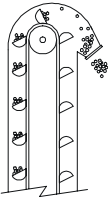

- commonly used for grain applications
- feeder discharge damping required when slow elevators (typically chain drive) produce heavily pulsing material discharge
- use deadbox if required to reduce material velocity from fast elevators (typically re-inforced belt drive)

Conveyor Belt

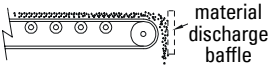

- produces a non-pulsing material discharge
- reverse flowguide transition (and/or material discharge baffle) often required for variable belt speeds or constant speeds in excess of 1 m/s (200 feet/minute)

Drag Conveyor

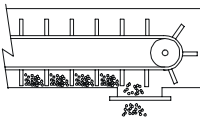

- operates at a constant (and relatively low) velocity
- reverse flowguide transition not normally required but use feeder discharge damping or a discharge baffle to minimize the pulsing material discharge

Vibratory Feeder

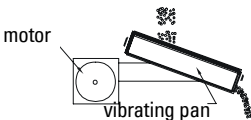

- produces a non-pulsing material discharge
- use reverse flowguide transition for variable speed varieties

Flowmeter In-Feed Chutes

The flowmeter in-feed chute delivers the material from the bin or feeder discharge to the flowmeter flowguide. The ideal in-feed chute pre-conditions the material flow to minimize the effect of abrasion, velocity variation, feeder discharge trajectory variation, and pulsing.

Feeder/Flowguide Transition

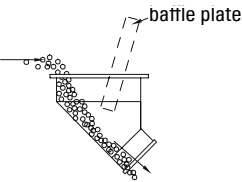
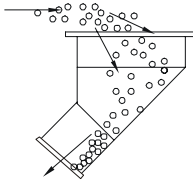

- reverse flowguide transition reverses direction of the bin or feeder material discharge before the material enters the flowmeter flowguide
- reversing direction forces the material into a desirable flow pattern rather than permitting material to be flung from the feeder, directly into the flowguide
- transition is especially important for high or variable speed feeders
- forward flowguide transition maintains the material in the same direction between the bin or feeder discharge and the flowmeter flowguide
- transition is acceptable for a low and constant velocity feeder
- if a forward flowguide transition must be used for a high or variable speed feeder application, install a baffle plate

ShortFall Chute

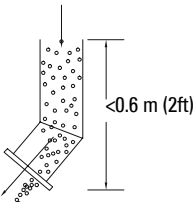

- material in-feed chute where the bin or feeder discharge to flowmeter flowguide fall is less than 0.6 m (2 ft)
- material velocity due to gravity minimized
- chute centreline and angle should coincide with that of the flowguide, for a distance greater than or equal to the flowguide diameter (before the flowguide inlet)

Long Fall Chute

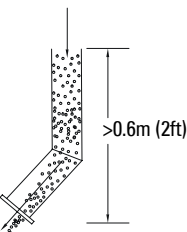

- material in-feed where the bin or feeder discharge/ flowguide fall is more than 0.6 m (2 ft)
- less desirable than the short fall chute because material velocity is greater, increasing flowmeter component abrasion
- greater distances after chute angle changes required to settle material into desirable flow patterns

Dogleg

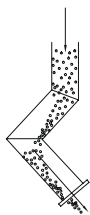

- used to reduce the detrimental effect of high or variable material velocity, especially when using a long fall chute
- for abrasive materials, line the chute with an abrasion resistant material, or use an in-feed deadbox

Deadbox



- installed where the chute angle changes. This will cause the material to impact upon itself, rather than the chute surface.
- used when the feeder discharge velocity is high, variable, where long fall chute angles change, and if the material is particularly abrasive

Pulsing Feeder Discharge Damping

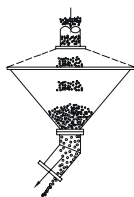

- install a temporary holding bin to receive pulsing material discharge from a feeder. Then the material is gravity fed from the bin to the flowmeter flowguide.
- provide manual or automatic control to ensure the holding bin is neither emptied nor overfilled while the feeder is in operation.
- bin could also be used for the integrator on-line calibration, (if so equipped). Refer to the integrator instruction manual for bin requirements.

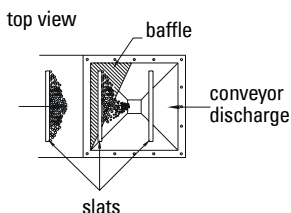

- for drag conveyors, use a baffle plate installed at the conveyor discharge to reduce the heavy material pulsing associated with this type of feeder

In-Feed/Discharge Air Pressure

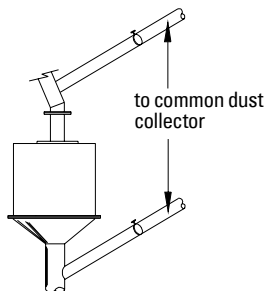

- when a material in-feed/discharge differential air pressure is anticipated, and rotary airlock feeders are not utilized, vent the in-feed and discharge chutes to a common dust collector
- install a tuning gate in each vent to balance the air pressure
- if a dust collector is not used, install an air bypass chute between the flowmeter in-feed and discharge chutes

Flowguide Capacity

Refer to the following chart, to ensure the flowguide capacity is suitable.

V SERIES FLOWGUIDE CAPACITY CHART

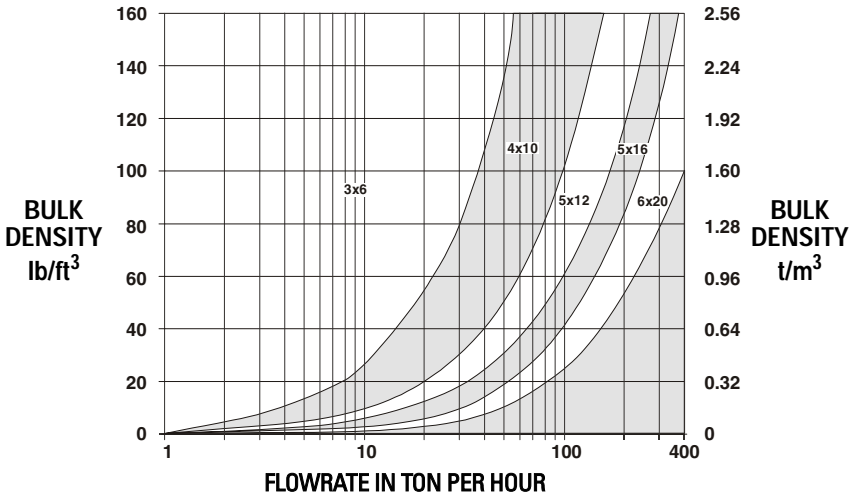

Note: If the material bulk density and flowrate is near a flowguide diameter upper limit, choose the next larger flowguide diameter.

Maintenance

Checks

If material sticks to the sensing plate, incorporate a program to ensure that the impingement area remains clean. If sticking persists, contact your Siemens Milltronics representative.

Check for wearing of the sensing plate. If wear is excessive, contact your Siemens Milltronics representative.

Unit Repair and Excluded Liability

All changes and repairs must be done by qualified personnel and applicable safety regulations must be followed. Please note the following:

- The user is responsible for all changes and repairs made to the device.
- All new components must be provided by Siemens Milltronics Process Instruments Inc.
- Restrict repair to faulty components only
- Do not re-use faulty components.

V-40 Outline and Mounting

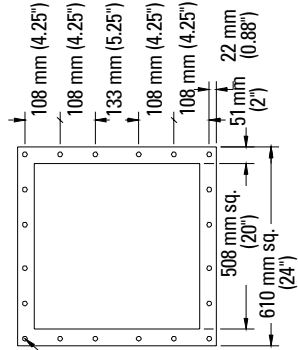
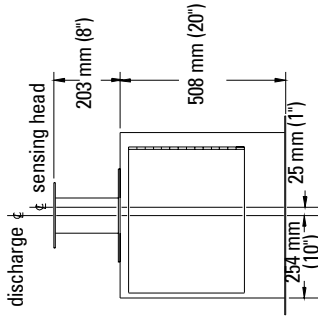
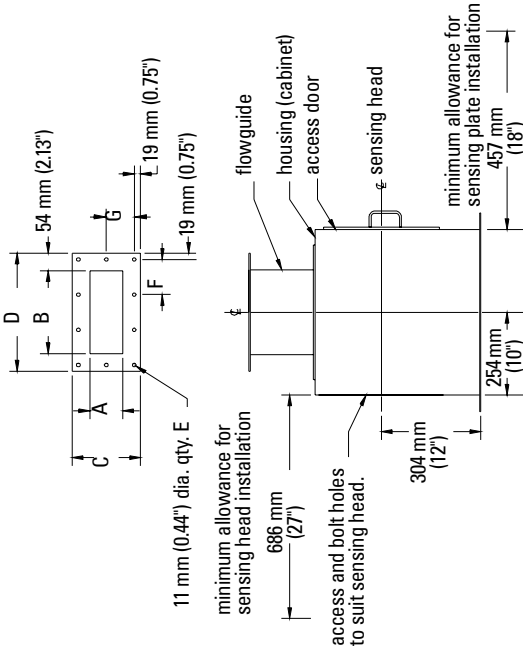

14 mm (0.56") dia.
20 holes

Notes:

1. Mild steel or stainless construction.
2. Sensing head support should be rigid and independent of housing for base mount versions.

Size	A	B	C	D	E	F	G
1	76 mm (3")	152 mm (6")	184 mm (7.25")	260 mm (10.25")	8 (4.38")	111 mm (4.38")	73 mm (2.88")
2	102 mm (4")	254 mm (10")	210 mm (8.25")	362 mm (14.25")	10 (4.25")	108 mm (4.25")	86 mm (3.38")
3	127 mm (5")	305 mm (12")	235 mm (9.25")	413 mm (16.25")	12 (3.69")	94 mm (3.69")	99 mm (3.88")

V-300 Outline and Mounting

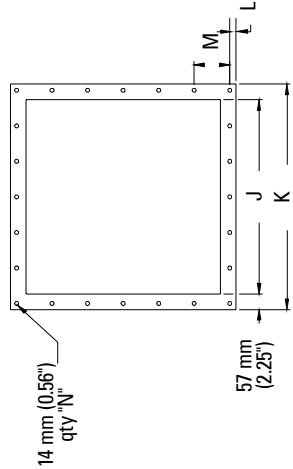
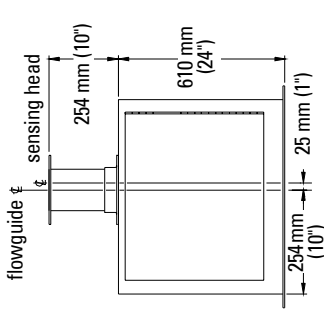
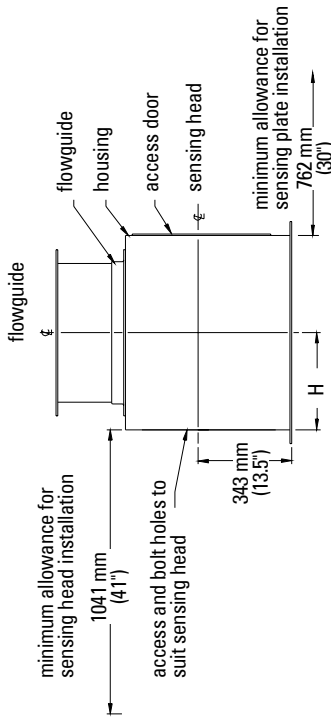
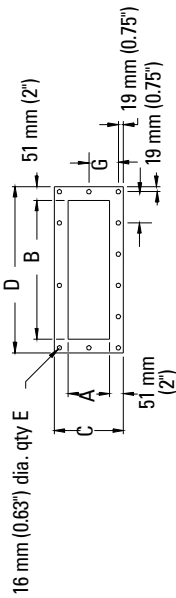

Size	A	B	C	D	E	F	G	H	I	J	K	L	M	N
1	127 mm (5.00")	406 mm (16.00")	229 mm (9.00")	508 mm (20.00")	12 (9.63")	957 mm (37.75")	305 mm (12.00")	330 mm (13.00")	610 mm (24.00")	21 mm (0.81")	74 mm (2.85")	21 mm (0.81")	137 mm (5.38")	20
2	152 mm (6.00")	508 mm (20.00")	254 mm (10.00")	610 mm (24.00")	14 (4.50")	108 mm (4.25")	356 mm (14.00")	381 mm (15.00")	711 mm (28.00")	22.4 mm (0.88")	826 mm (32.5")	22.4 mm (0.88")	130 mm (5.125")	24

Notes:

1. Mild steel or stainless construction.
2. Sensing head support should be rigid and independent of housing.



www.siemens-milltronics.com

Siemens Milltronics Process Instruments Inc.
1954 Technology Drive, P.O. Box 4225
Peterborough, ON, Canada K9J 7B1
Tel: (705) 745-2431 Fax: (705) 741-0466
Email: techpubs@siemens-milltronics.com

© Siemens Milltronics Process Instruments Inc. 2003
Subject to change without prior notice



Printed in Canada

Rev. 1.0