

Wire colour codes	
Black	BK
Blue	BU
Brown	BN
Green	GN
Grey	GY
Orange	OG
Red	RD
White	WH
Yellow	YE
Green/Yellow	GYE

Valid for:
Control Box UR3e *
Control Box UR5e and UR10e

Supply:
 100-265 VAC
 47-440 Hz

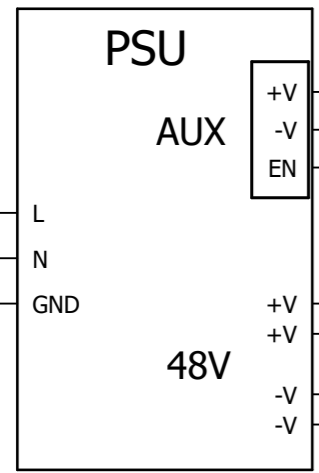

* In UR3e version only one RD conductor and one BK conductor available.

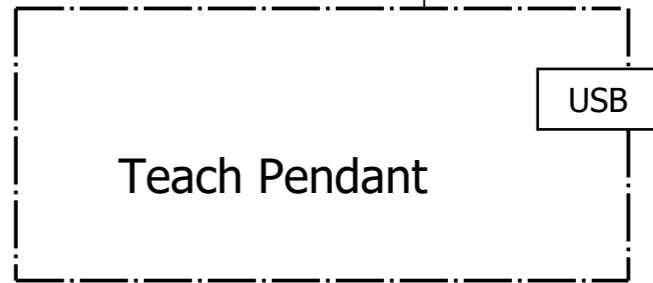
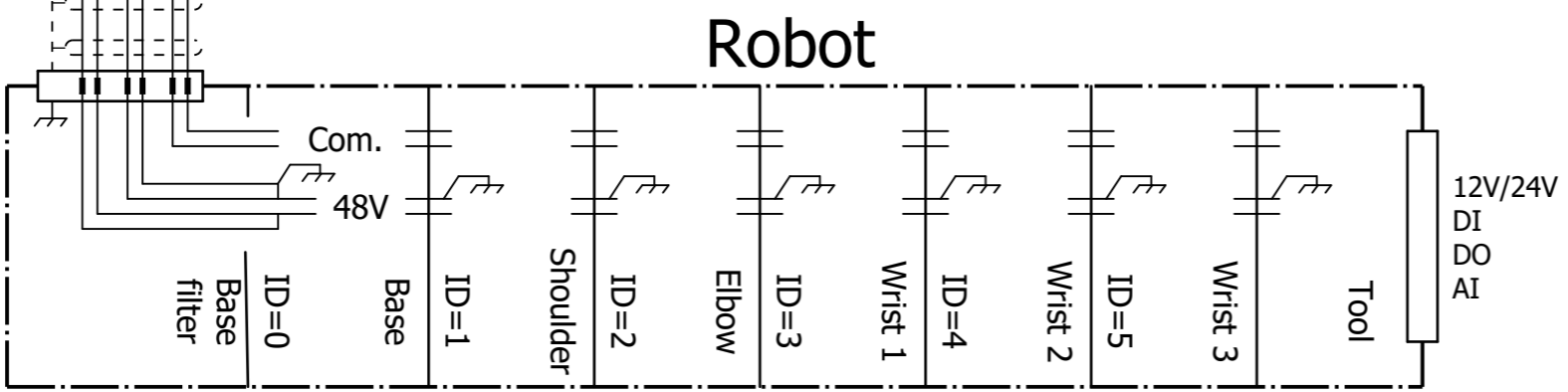
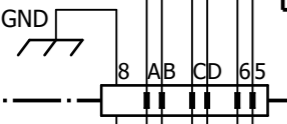
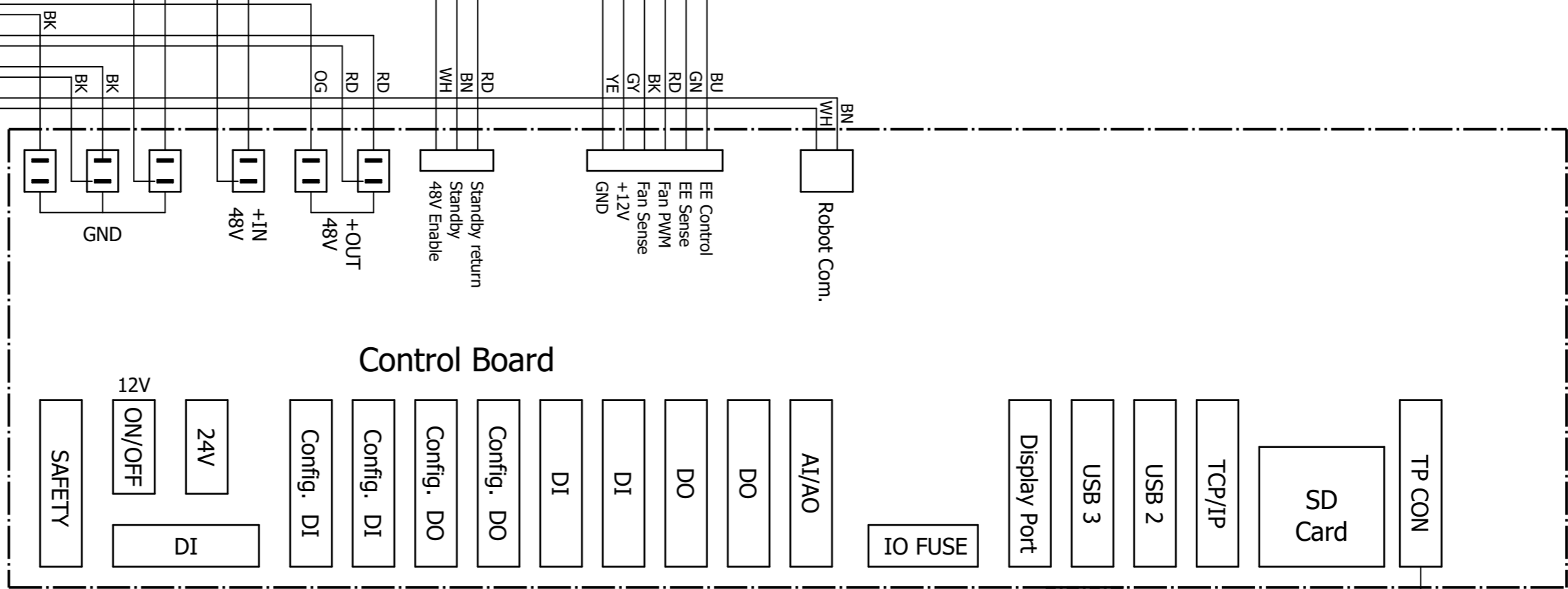
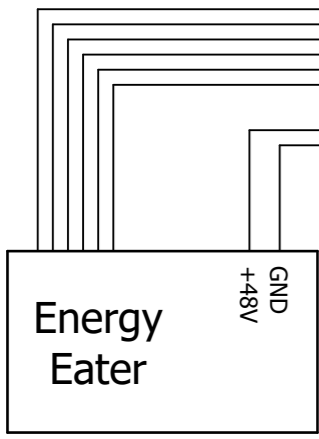

UR3e, UR5e and UR10e Robot arm

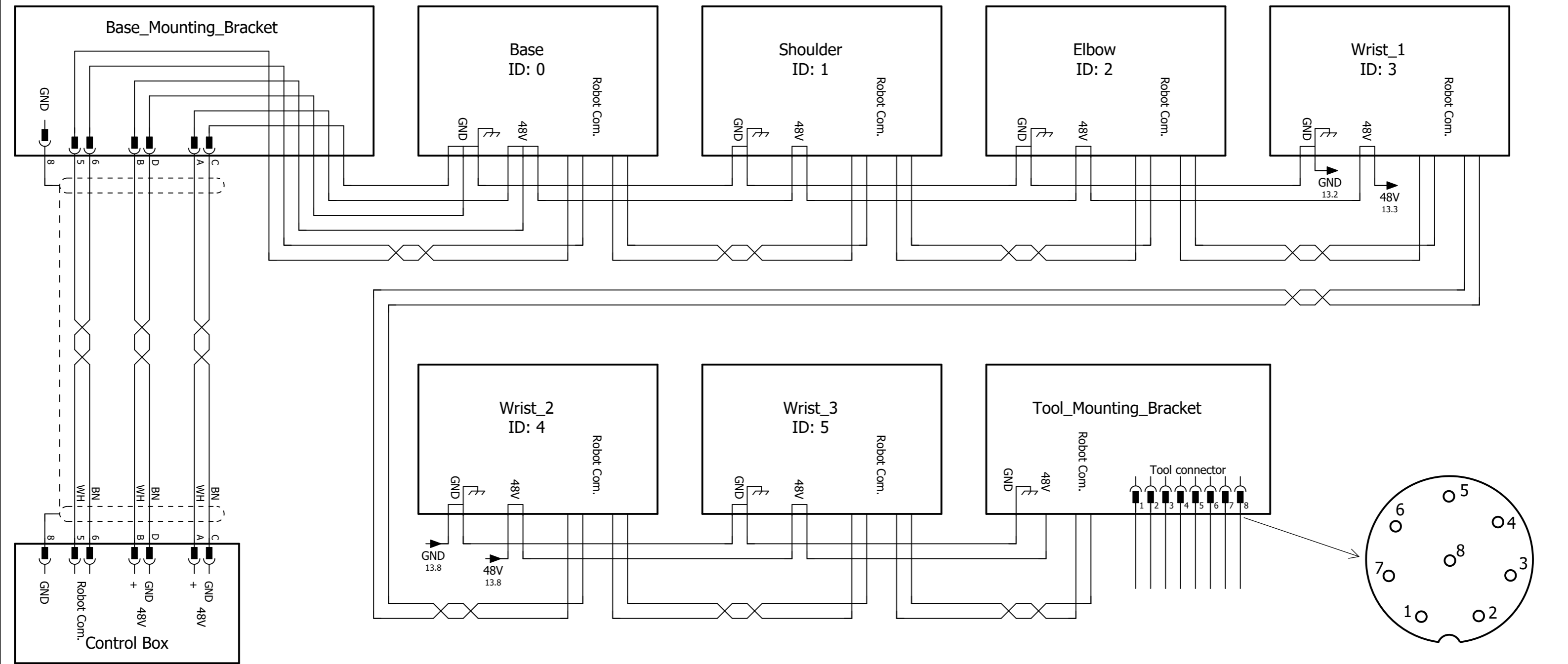

			Date	09-05-2019	Universal Robots		UR3e, UR5e and UR10e Robot arm		= UR_e
			Ed.						+
			Appr						
Modification	Date	Name	Original		Replacement of	Replaced by			
								Dwg. No.:	5.0.0.1
									Page 13
									Page 19

-UR_e
/16.0
/17.0
/18.0
/19.0
/20.0
/21.0
/22.0
/23.0
/24.0
/25.0
/26.0
/27.0
/28.0



UNIVERSAL ROBOTS

UR3e, UR5e and UR10e

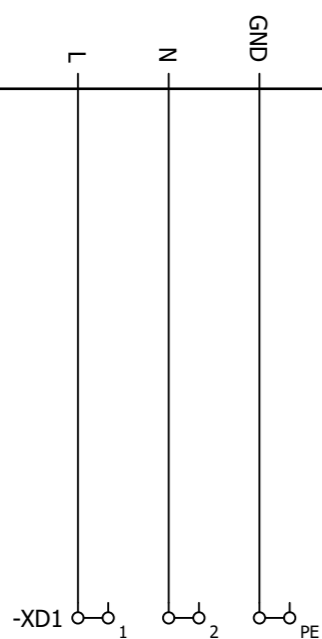

Supply
100-265 VAC
47-440 Hz



Data I/O

			Date	09-05-2019	Universal Robots		UR3e, UR5e and UR10e Control Box I/O		= UR_e	
			Ed.						+	
			Appr						Dwg. No.: 5.0.0.1	
Modification	Date	Name	Original		Replacement of	Replaced by			Page	15
									Page	19

-UR_e
/15.0



UNIVERSAL ROBOTS

UR3e, UR5e and UR10e

Safety

Emergency Stop

Safeguard Stop

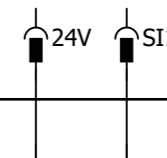
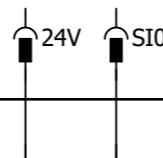
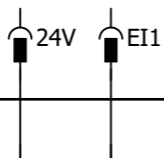
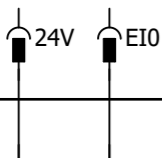

Default connections

Default connections

			Date	09-05-2019	Universal Robots		UR3e, UR5e and UR10e Control Box I/O		= UR_e	
			Ed.						+	
			Appr							
Modification	Date	Name	Original		Replacement of	Replaced by			Dwg. No.:	5.0.0.1
									Page	16
									Page	19

-UR_e
/15.0



UNIVERSAL ROBOTS

UR3e, UR5e and UR10e

Remote

Power

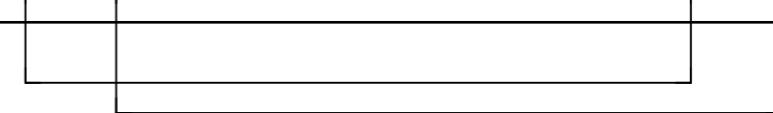
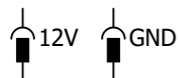

Default connections

			Date	09-05-2019	Universal Robots		UR3e, UR5e and UR10e Control Box I/O		= UR_e	
			Ed.						+	
			Appr						Page 17	
Modification	Date	Name	Original		Replacement of	Replaced by			Dwg. No.:	5.0.0.1
									Page	19

-UR_e
/15.0



UNIVERSAL ROBOTS

UR3e, UR5e and UR10e

Configurable Outputs



			Date	09-05-2019	Universal Robots		UR3e, UR5e and UR10e Control Box I/O		= UR_e	
			Ed.						+	
			Appr							
Modification	Date	Name	Original		Replacement of	Replaced by			Dwg. No.:	5.0.0.1
									Page	20
									Page	19

-UR_e
/15.0



UNIVERSAL ROBOTS

UR3e, UR5e and UR10e

Configurable Outputs

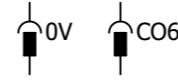
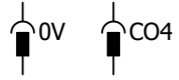

			Date	09-05-2019	Universal Robots		UR3e, UR5e and UR10e Control Box I/O		= UR_e	
			Ed.						+	
			Appr							
Modification	Date	Name	Original		Replacement of	Replaced by			Dwg. No.:	5.0.0.1
									Page	21
									Page	19

-UR_e
/15.0



UNIVERSAL ROBOTS

UR3e, UR5e and UR10e

Digital Inputs

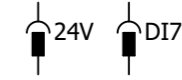
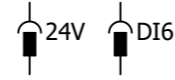
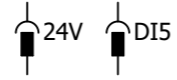
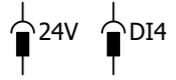

			Date	09-05-2019	Universal Robots		UR3e, UR5e and UR10e Control Box I/O		= UR_e	
			Ed.						+	
			Appr							
Modification	Date	Name	Original		Replacement of	Replaced by			Dwg. No.:	5.0.0.1
									Page	23
									Page	19

-UR_e
/15.0



UNIVERSAL ROBOTS

UR3e, UR5e and UR10e

Digital Outputs

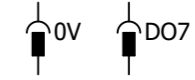
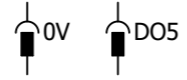
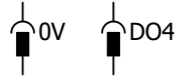

			Date	09-05-2019	Universal Robots		UR3e, UR5e and UR10e Control Box I/O		= UR_e	
			Ed.						+	
			Appr							
Modification	Date	Name	Original		Replacement of	Replaced by			Dwg. No.:	5.0.0.1
									Page	25
									Page	19



UNIVERSAL ROBOTS

UR3e, UR5e and UR10e

Analog I/O (is not galvanically isolated from Control Box)

Analog Inputs



Analog Outputs



			Date	09-05-2019	Universal Robots		UR3e, UR5e and UR10e Control Box I/O		= UR_e	
			Ed.						+	
			Appr							
Modification	Date	Name	Original		Replacement of	Replaced by			Dwg. No.:	5.0.0.1
									Page	26
									Page	19

